

INSTRUCTIONS FOR INSTALLATION AND USE

TRUE VISION



Distributor/Manufacturer
M-Design Benelux BVBA
B-8210 Zedelgem - Belgium

11-2022



PASSION FOR FIRE

VERY IMPORTANT
INSTALLATION INSTRUCTIONS
FOR THE M-DESIGN GAS
FIREPLACES

**THE SUPPLIER TAKES NO RESPONSIBILITY FOR ANY
POSSIBLE DAMAGE, POOR WORKING APPLIANCES AND
ACCIDENT AS A RESULT OF INCORRECT
INSTALLATION**



PASSION FOR FIRE

MAINTENANCE GAS FIREPLACE M-DESIGN

**THE M-DESIGN GAS FIREPLACES MUST BE CHECKED EVERY
2 YEARS AND GET A
MAINTENANCE. THIS IS ALSO TO MAINTAIN YOUR
WARRANTY. IF THIS WILL BE NOT
OBSERVED, THE WARRANTY FELL.
YOU CAN RELY ON M-DESIGN TO MAKE THIS CHECK FOR
YOU, OR YOU CAN DO THIS BY YOURSELF AND FOLLOW
THE METHOD BELOW.**

SUMMARY

1. GENERAL REMARKS.....	5
2. CONNECTION.....	5
3. INSTALLING THE FIREPLACE.....	6
3.1.1 Positioning the fireplace.....	6
3.1.2 Nearbox (Gasunit).....	7
3.1.3 The Gas connection.....	8
3.1.4 Electrical connection	9
3.1.5 Modification natural gaz to propane.....	9
4. INSTALLING THE CHIMNEY	10-13
5. FLAME ADJUSTMENT SETTINGS.....	14
6. INSULATION AND FINISHING	14
7. CONVECTION CURRENT	15-16
8. POSITIONING THE LOGS	17-25
9. FIRST-TIME USE.....	26
10. SAFETY, ADVICE AND MAINTENANCE	26
11.GUARANTEEE	27
12. REMOTE CONTROL	28-30
13. CE CERTIFICATION	31-33
14. DRAWINGS	34-45
15. DESIGN GRILLS	46

OPEN EN CLOSE THE DOOR

For initial setup, you need to clean the window and clear the fireplace of any dust and grease that is left behind. This is also the only maintenance action that may be performed on the device by the user.



Thanks to a patented system, the door can be easily opened at an angle of 45° to allow a user-friendly cleaning of the window



OPEN

Above the glass (below the upper frame) hooks are provided (left, right and center). Push it upwards with your fingers. the window can now be opened.



CLOSING

To close, push the door gently (but not too soft) against the hooks. Make sure that all hooks are hooked

1. General remarks

This is an appliance using the closed combustion system, designed for the atmosphere and comfort of your living-room. It constitutes an efficient source of heat and gives the impression of a real fire. The balanced flue appliances are based on the principle of natural extraction from the firebox, which eliminates flue gas outside and brings in air (oxygen) from outside the house which is necessary for combustion of the gas. It uses to this effect two concentric pipes. The internal pipe ensures the elimination of burned gases and the external pipe brings in combustion air. The advantage of this principle is that the equipment works independently of the atmosphere which predominates in the house.

2. Connection

This appliance must be connected by an approved installer in accordance with the most recent regulations in force. On the basis of your order specifications, this appliance is designed for natural or propane gas.

Read the instructions before installing and using this appliance. Before installing the appliance, please check the local regulations about this type of appliance (identification of the type of gas, etc.) and check that the furnace is adapted to your means of installation.

The appliance must be connected to the type of gas mentioned on the appliance. Never connect a propane burner to natural gas or vice versa!

It is imperative that the installer sees to the following:

- The appliance must be subject to an air tightness test of the gas and elimination of flue gases.
- The concentric pipe, if already available, must be working correctly.
- The running of the control valve, lighting of the pilot light, the main burner and the thermocouple must all be checked.

This appliance has been programmed and factory sealed. The sealed parts cannot be modified. The appliance may therefore also be installed in airtight accommodation and accommodation equipped with mechanical ventilation. It constitutes ambient heating even in accommodation equipped with a closed ventilation system.

3. Installing the fireplace

After having checked the appliance, you are ready to install your appliance. This is done as follows

3.1.1 Positioning the appliance

Place the appliance on a stable surface using the adjustable feet. Adjust the height of the appliance turning the bolt.

The appliance must not be placed directly on the floor as you need to allow natural convection. The apertures for the air supply (IN) is situated underneath the appliances. Minimum height to floor = 35mm

Minimum and Maximum height of the appliance :

Adjusting the height of the appliance Min 35mm to 450mm (floor to under the appliance).

If you want the fireplace to be installed with a different height, unscrew the nut to remove the feet. Grind the desired height on foot. The distance between two holes is 40mm. With the fireplace is provided 4 small saucers. Use to get the stud under your feet.

If you want to install the fireplace at the minimum height of 35mm, measured from the floor to below the firebox: remove the foot and unscrew the nut below the foot. Aim the nut in the tarred hole that is located below the hearth in the corner. Do the same for the four feet.

The minimum distance from the floor to the bottom of the frame is 244 mm.

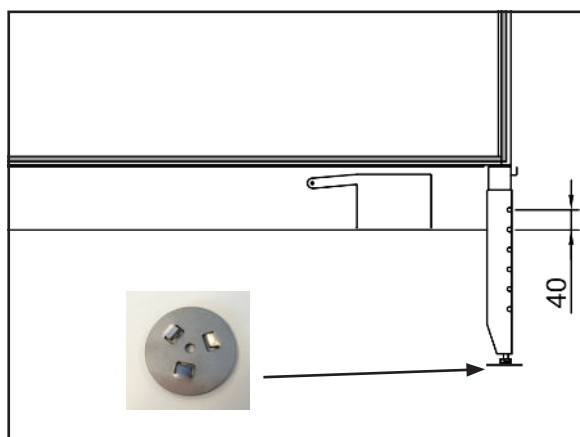

3.1.2 Nearbox (gasunit)

For safety reasons, The gasbattery or "NEARBOX" is fixed with screws at the rear of the unit during transport .

THE UNIT CANNOT BE INSTALLED WITH THIS NEARBOX FIXED AT THE REAR, IT IS MANDATORY TO UNSCREW THE BATTERY FROM THE REAR PRIOR TO INSTALLATION .



unscrew 4 screws in the corners (key 8)

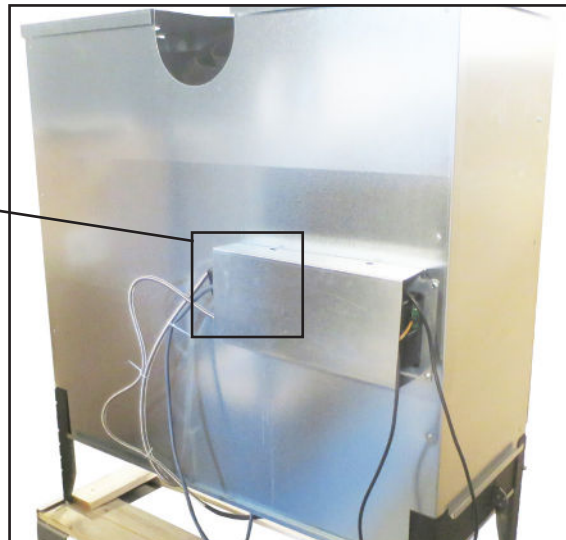

to second burner or side burner ←

to main burner ←

Electro magnet ventil 1 or 2 burners ←

gas connection 1/2" ←

Gas valva
VK4105ME5004

Transmitter burner

reciever
DFGT-03MC01 V09

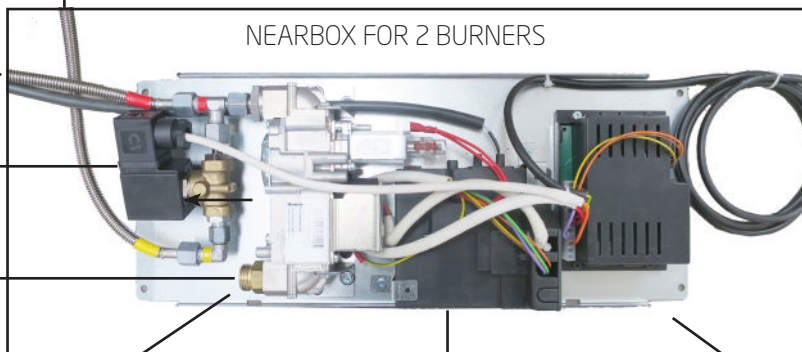

NEARBOX FOR 1 BURNER

to main burner ←

gas connection 1/2" ←

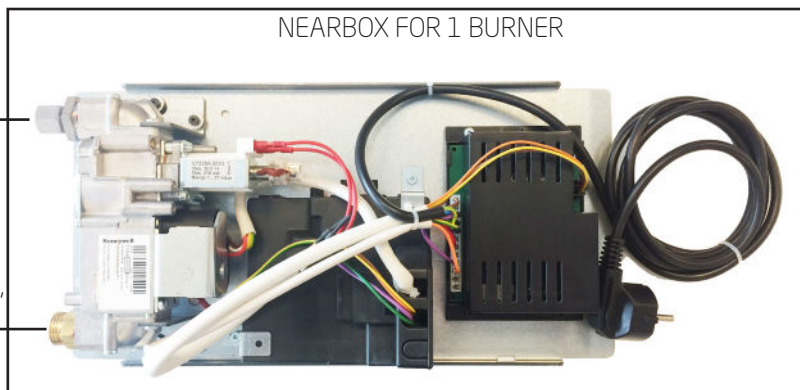

Dimensions gasunit : 455 x 188 x Height 64mm

(455 2 burners)

3.1.3 The Gas connection

After the "NEARBOX" has removed from the of the back of the fire, you can place it loosely on the ground in proximity to the opening provided in the wall of mantelpiece. The device is always connected with an approved gas tap 1/2, and preferably with a yellow gasflexible that is reachable at all times. Provide the mantelpiece with a door so that the valve and the electrical connection is easily accessible.

True Vision is provided with a direct ignition, no starting pilot

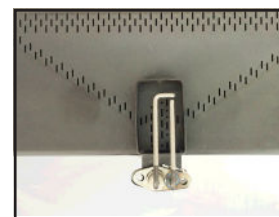

ATTENTION : DO NOT PLACE ANY DECORATION ON THE DIRECT IGNITION PIN (be carefull to stay out of the little rectangular zone with the dcoration)

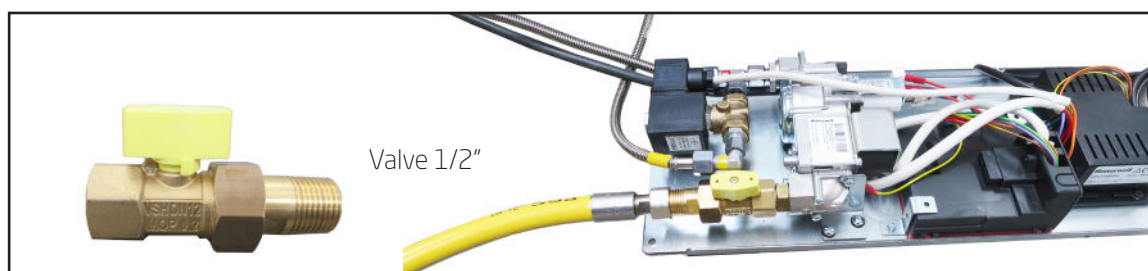
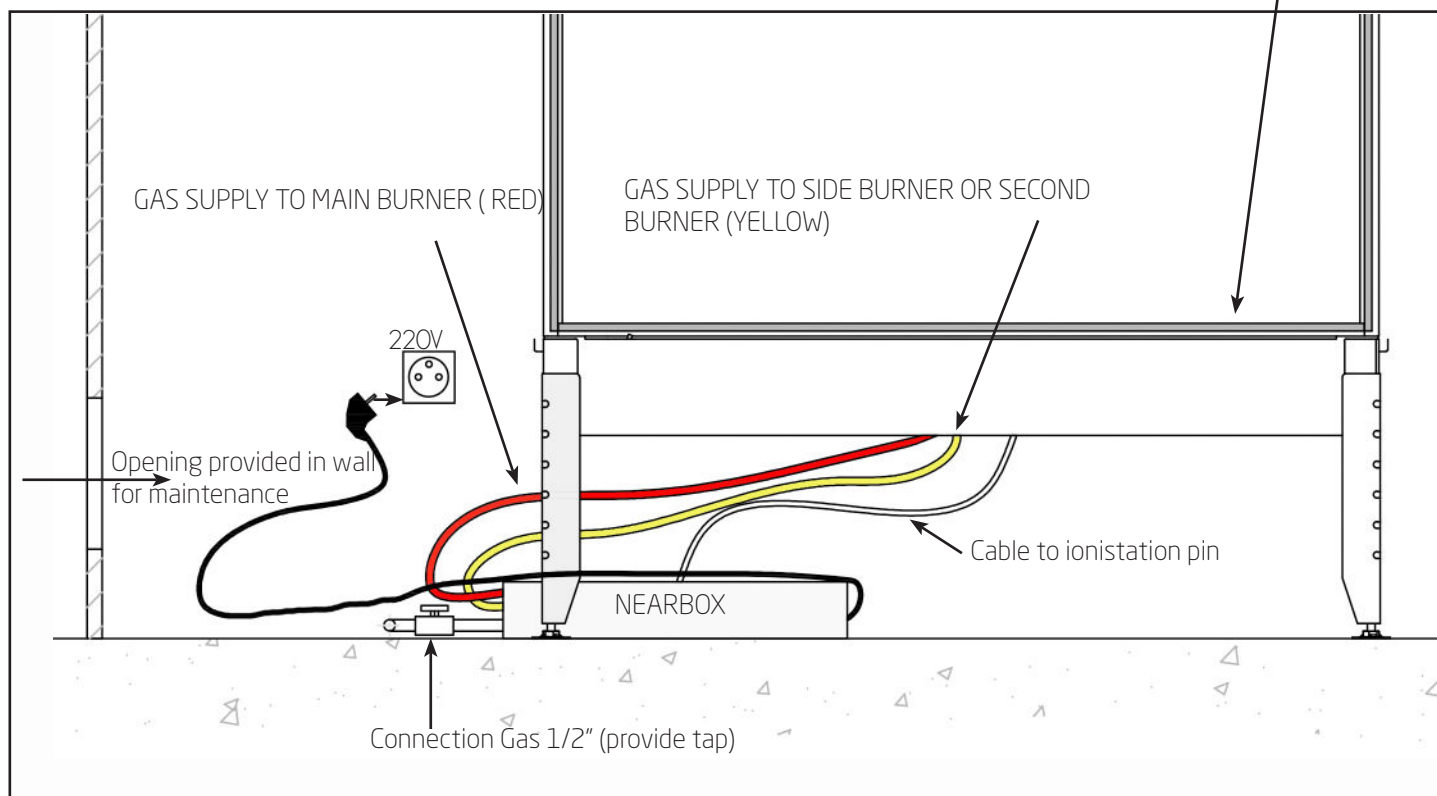

3.1.4 Electrical connection

These appliances are equipped with a radiographic remote control, making an earthed 220V socket necessary.

You should bear in mind that the appliance must be connected to all electrical supplies for the purposes of service.

It's obligatory to connect an earth current.

3.1.5 Modification natural gaz to propane

Modification of the fireplace can only be done by the manufacturer or an approved installer. A new signal plate is provided.

4. Installing the chimney

Install the concentric flue duct as indicated by ONTOP - METALOTERM. The only authorised pipes are ONTOP Metaloterm™. ONTOP-METALOTERM tested our appliances with their conduct and we only guarantee a good working of the appliance with those. Between the external wall of the pipe and the wall or the ceiling, you should allow for a clearance of at least 50mm and protection that is suitable against temperatures of around 130°C. The passage of the front panel cowl in the external wall must be filled in using silicone mastic.

The concentric flue duct should not be reduced to 150/100 for all True Vision.

4.1. ROOF EXIT (C31)

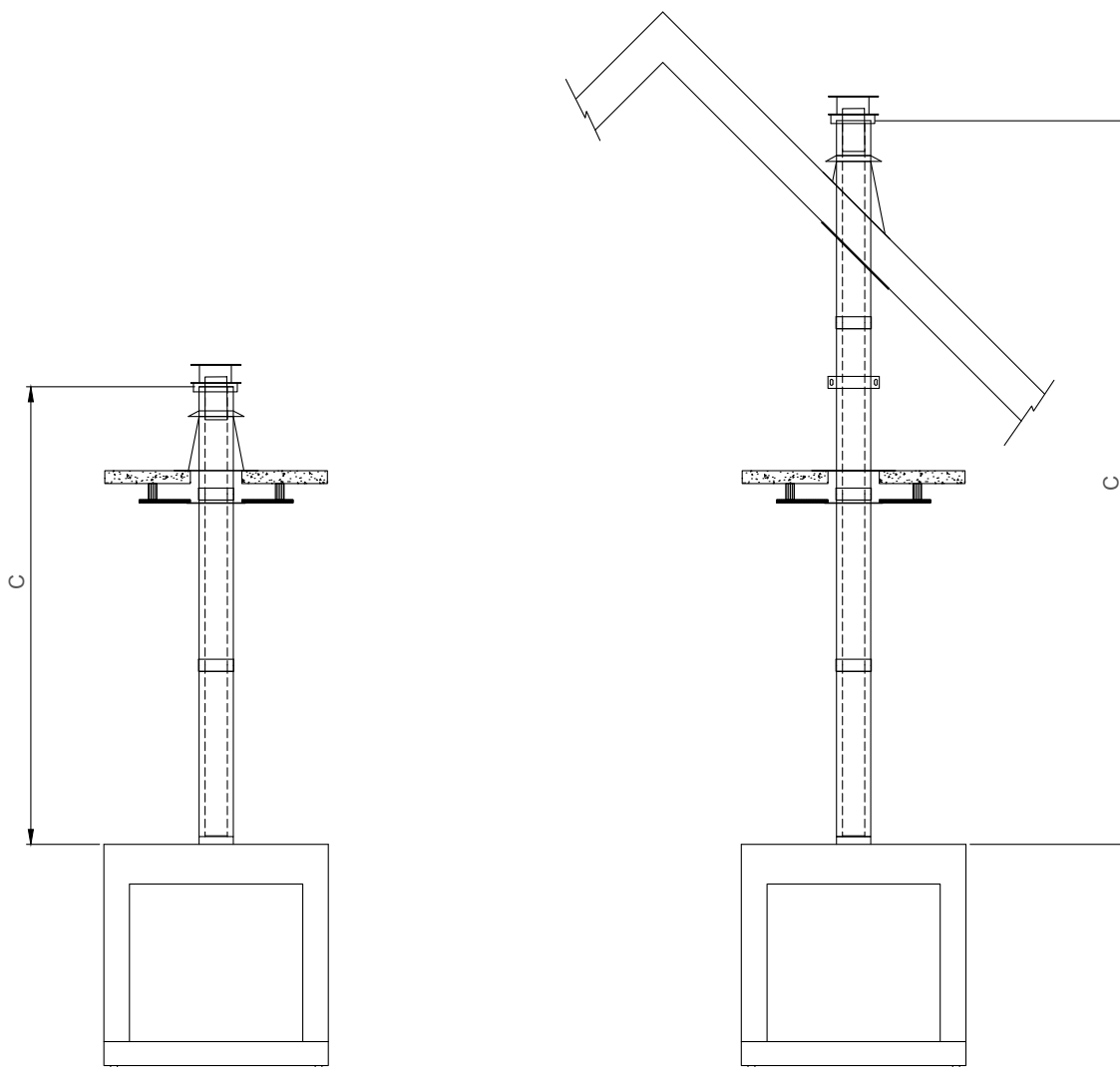

Ø 200/130		
Appliance	C (min)	C (max)
850V / 550V / 550DV / 850DV / 850 VDC	2 m	10m
850DC/CL-CR/VCL-VCR / 650DC / 550DC-CL-CR	2 m	9m
1150V / 1050 DC/CL-CR/VCL-VCR/VDC 850VL / 850DVL / 1300V / 1300H-DC-CL-CR Quatro	2 m	8m

4.2. ROOF EXIT VIA EXISTING CHIMNEY (C91S)

Ø200/130		
Appliance	C (min)	C (max)
850V / 550V / 550DV / 850DV / 850 VDC	2 m	10m
850DC/CL-CR/VCL-VCR / 650DC / 550DC/CL-CR	2 m	9m
1150V / 1050 DC/CL-CR/VCL-VCR/VDC 850VL / 850DVL / 1300V 1300H-DC-CL-CR Quatro	2 m	9 m

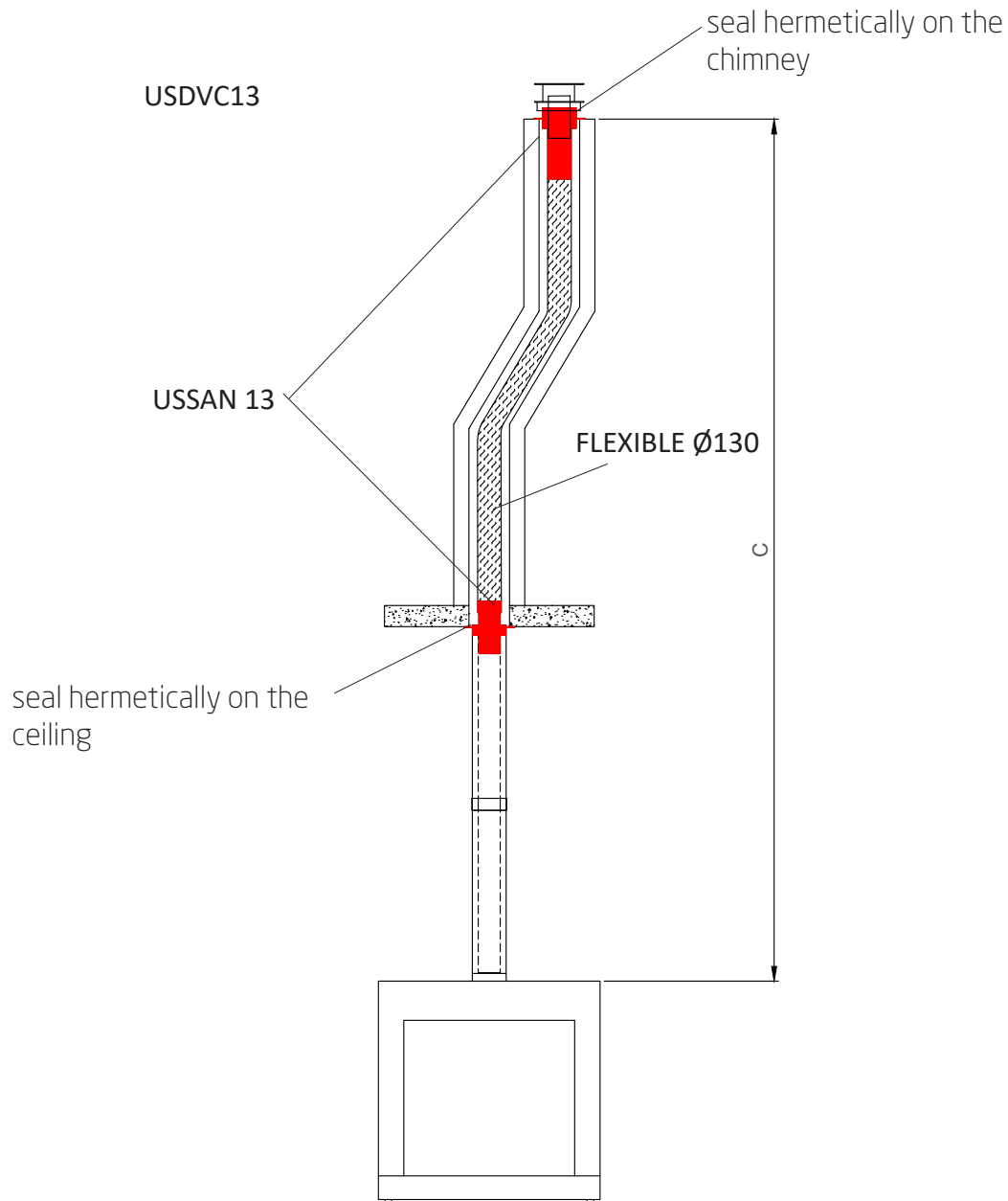

USSAN 13 sanitation kit: required when connecting to an existing chimney. This one must be hermetically sealed to the ceiling and the USSAN13 on the top of the chimney must also be hermetically sealed at the exit.

CAUTION: It is imperative to sweep the chimney and clean it from dust and soot. The fireplace functions as an air inlet and if the fireplace is not clean, it will cause unpleasant odors.

4.3. WALL EXIT (C11)

Ø 200/130			
Appliance	A (min)	B (min)	B (max)
850V / 850DV / 850VDC 550V / 550DV	1m 0,75m	Wall Exit	A+8m
850DC/CL-CR/VCL-VCR / 650DC 550DC/CL-CR / 1050VDC	1m	Wall Exit	A+7m
1150V / 1050 DC/CL-CR/VCL-VCR 850VL / 850DVL	1m 0,75m	Wall Exit	A+7m
1300 H-DC-CL-CR Quatro	1m	Wall Exit	A+5m
1300V	forbidden	forbidden	forbidden

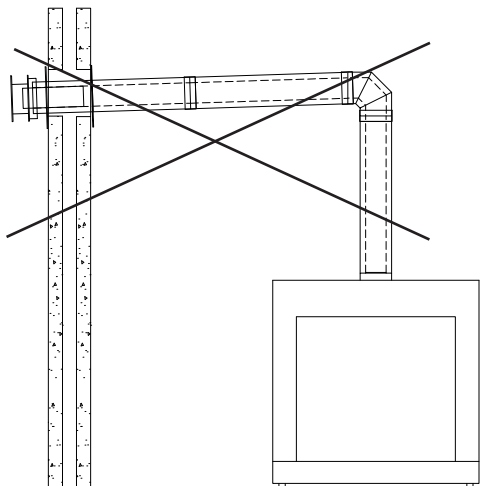
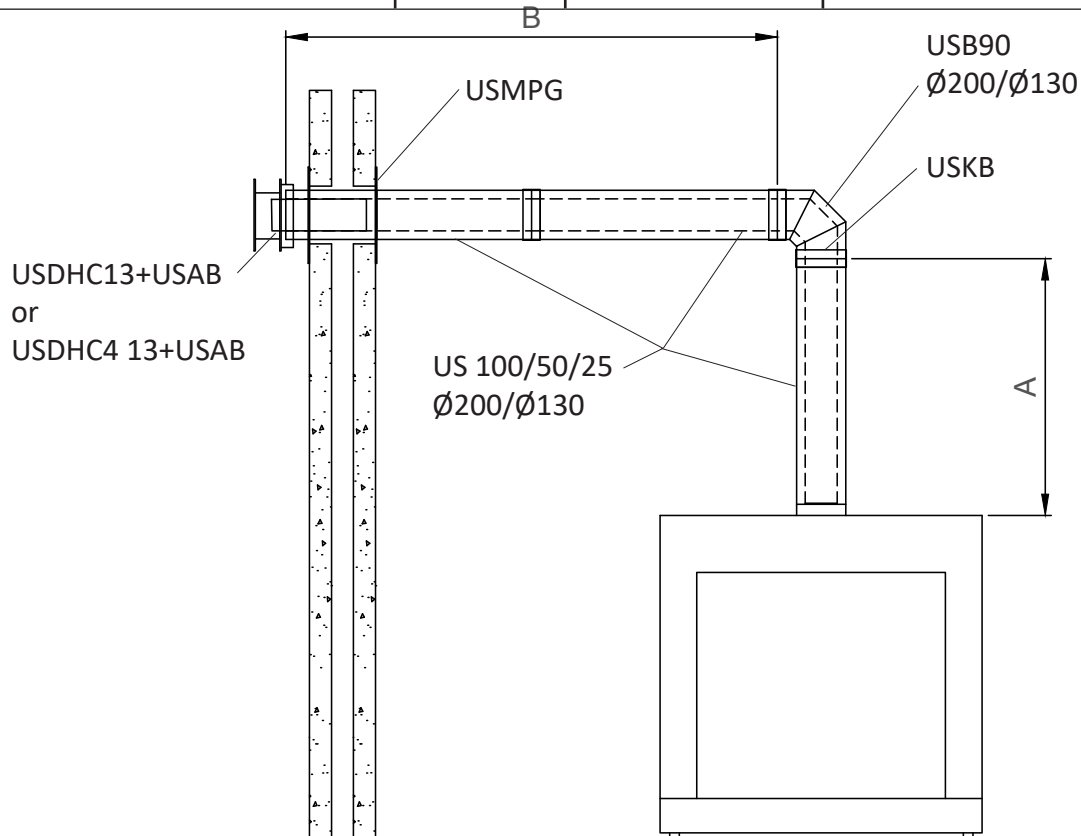

IMPORTANT:

Be carefull every horizontal part does not have a negative in clination in direction of the outlet. It is even better, when possible to have a little inclination of 2 or 3 degrees ascending to avoid rain and condenstation in the tube.

4.4. ROOF EXIT WITH BEND

Ø 200/130				
Appliance	A (min)	B (max)	C (min)	(A+B+C)max
850V / 850DV / 850VDC 550DV / 550V /	1 m 0,75m	(A+C) + 7m	B-A-9m	20m
850DC/CL-CR/VCL-VCR / 650DC 550 DC/CL-CR / 1050VDC	1 m	(A+C) + 6m	B-A-8m	19m
1150V / 1050 DC/CL-CR/VCL-VCR 850VL / 850DVL	1 m 0,75m	(A+C) + 6m	B-A-8m	19m
1300 H - DC - CL- CR Quatro	1m	(A+C)+4m	B-A-6m	16m
1300V	forbidden	forbidden	forbidden	forbidden

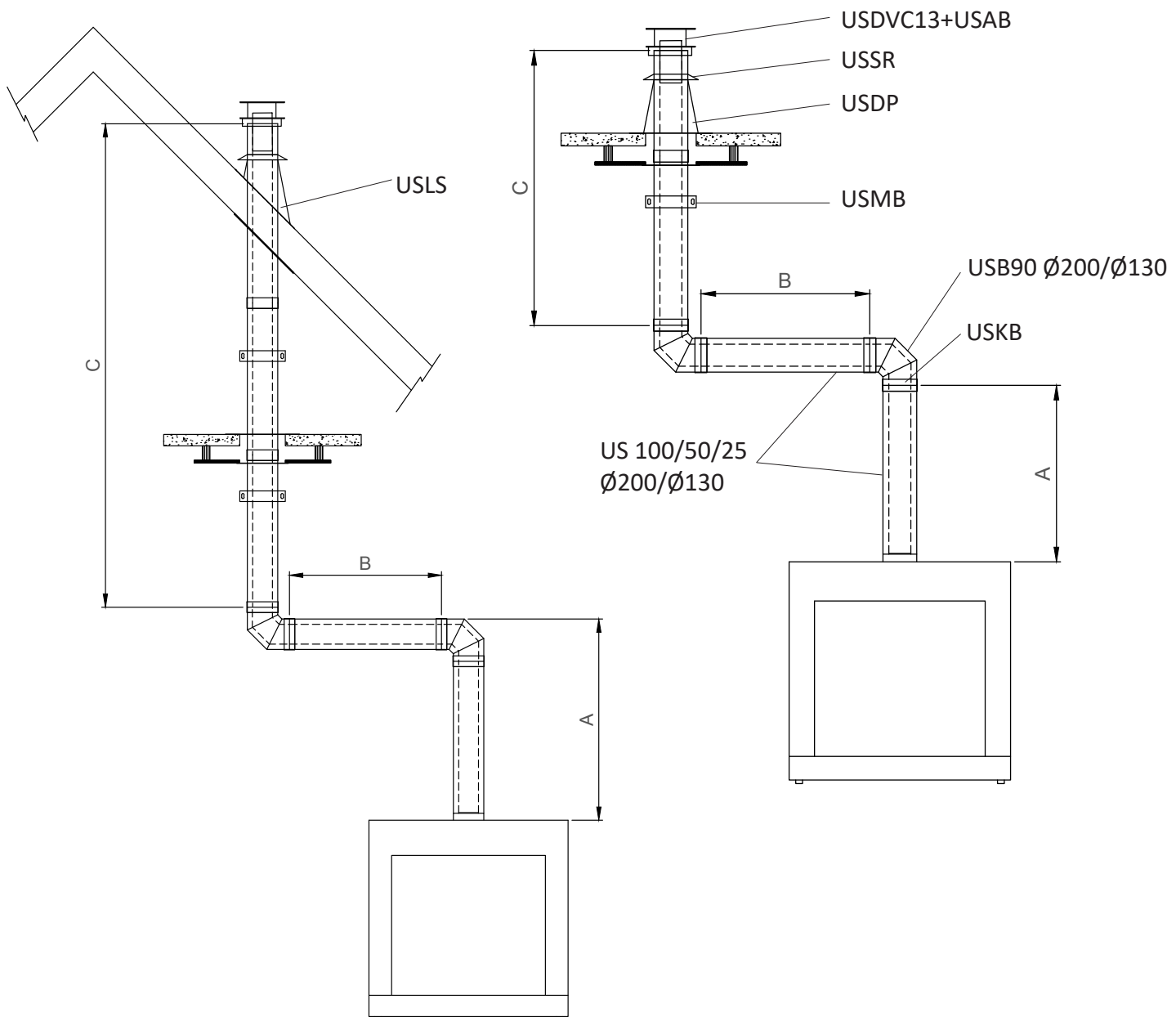

Appliance	Ø 200/130
All True Vision	for each 90° bend subtract 1m horizontally or add 1m vertically
All True Vision	for each 45°/30°/15° bend subtract 0,5m horizontally or add 0,5 m vertically

For the 1300V, **ONE** direction change of 45°/30°/15° is allowed. See chapter 4.1. Roof Exit page 10

5. Flame adjustment settings

Before initial setup, you need to clean the window (from outside and inside) and fireplace of any dust and grease. If you do not clean the glass properly, after lighting up the fireplace it can remain still on the glass. After installing the fireplace correctly on the concentric tube or chimney system, you must make a flame adjustment according to the draft (see chapter 4 page 9. Installing the chimney + use restriction rings).

The air intake for flame can be adjusted in fireplaces. Setting element is situated on the left side of the bottom plate in the combustion chamber. Adjustment of air intake may only be set out by a specialist.

At the first ignition of fireplace first test if ignition electrode work correctly.

Close the valve on gas connection, open the door on fireplace and start fireplace by remote control. Ignition electrode has to spark. If it does not spark, check cables and electrode. Then subsequently if electrode works correctly, open the gas valve and repeat ignition with opened door. Electrode should start the fire on the burner. When the fire burns evenly over the entire length of burners including secondary burners, the door can be closed and the flame can be set to local condition.

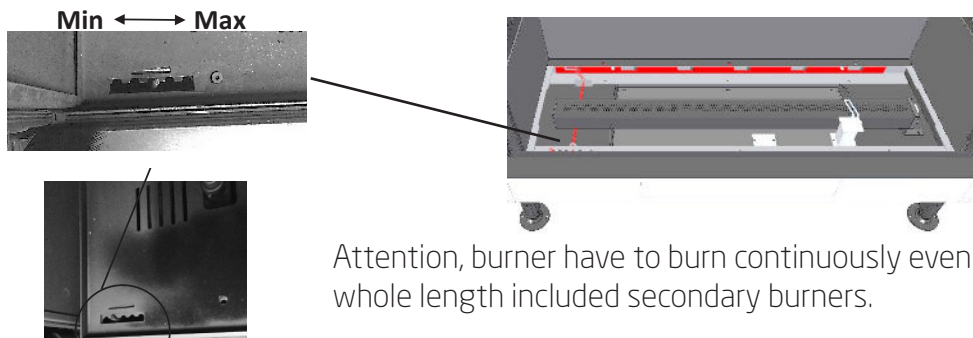

It is needed to wait 30-60 minutes until the setting is fully shown up in the fired fireplace. Natural gas is first burning by blue colour and it will turn yellow in time, LPG burning becomes quicker yellow.

If the flame is blue, it can mean that there is too much air in the combustion chamber but also that there is too little air. If there is too much air, the flame moves very quickly.

By adjustment must be taken to account that the more yellow the flame is the quicker glass can get dirty.

6. Insulation and finishing

Please, follow this instruction. The appliance can overheat if you do not follow these instructions. Errorcode F02 will appear !

Once installation is complete, the appliance can be fitted. Before doing so, check the tightness of the gas pipe one more time. Light the appliance and check that it is working: check the tightness of the gas pipe and the smoke pipe. Once you have checked everything, you can perform the final insulating and finishing operations.

The built-in part of the appliance tends to be very warm. Please check that the appliance is not too narrowly fitted and that there is adequate space for the elimination of hot air. For insulation of the appliance, we advise you to use M Design insulating plates. You are advised against using any other insulation product. Inflammable materials as well may not be used for the finishing.

Masonry must be raised around the fireplace. Due to the expansion of the fireplace during combustion, a gap of at least 5 mm must be provided at the front of the fireplace and 4 cm on each side of the appliance. The masonry must not rest on the fireplace. **THE FIREPLACE MUST BE FREE.** Always leave 2 mm clearance between the inner frame and the masonry.

7. Convection current

Please, follow this instructions. The appliance can overheat if you not apply those instructions. Errorcode F02 will appear!

It is MANDATORY to equip the fireplace with a convection kit consisting of inlets and outlets which are connected to stretchable hoses from 3m to 5m.

In this way is created a circulation and evacuation of the heat by convection.

This is very important to avoid overheating in the firebox casing and also to distribute the air hot air in the room or in another adjacent room (office, kitchen, ...)

This system directs the heat inside the room using hoses (150mm dia.). It is necessary to open minimum 2 hot air outlets. For the installation of these ducts, limit their lengths, avoid as much as possible elbows and changes of direction, because the losses of speed generated, decrease the efficiency of the air outlets at the end of travel. We advise you to install the hot air grilles at the same height to have the same heat provided. M-Design has developed hot air and ambient air outlet grilles available from your dealer (see page 16).

Outlet grids have two or four hose connections (2/4 hoses on 1 grid!).

The air inlet grilles (not to be connected with a hose) must be placed as low as possible at the bottom of the fireplace.

ATTENTION : A house is never completely 100 % dustfree, heating appliances and warmth circulation create dust particles. During the periods where you are not using the fireplace, dust is accumulated in the flexible pipe and and the grills
This could cause a problem with a smell, so we would certainly advise you to clear the flexible and air inlets and outlets using a vacuum cleaner regularly. The smell caused by these dust particles will disappear after you have used the fireplace again a few times. (This phenomenon is very common and can be compared to the gray traces appearing above your radiators.) Optionally you can order design metal lids to cover the inlets and outlets during the summertime .

7.1. CONVECTION GRILLS

EXIT CONVECTION: You can choose between 3 models of grids according to your taste or according to the fireplace: Grid Design (2 connections), Grille design long small model (2 connections) or long model (4 connections)

AIR ARRIVAL (ENTRY CONVECTION): You have the option to choose between inlets 2dm³ or 4dm³

Design Grills (outlet)
with to connectors



Design Grill Long (outlet)



Outlet

Outlet



Inlet Grill 2 dm³

Inlet

Inlet



Inlet Grill 4 dm³

ATTENTION:

if the installer opens the openings in advance, these must be covered during the work (grinding, drilling, sawing, etc.). Dust released during installation will otherwise sneak into convection circuit. Dust can never be eliminated properly and give off a lingering smell when using the appliance.

Once the installation is complete, it is imperative to aspirate or blow the convection channels with compressed air (be sure not to return dust to the convection chamber of the fireplace).

Woodset True Vision : SET H1 (not for 1300V)



Angel's hair (unex glow)
+ 5 packets Imitation coal

WARNING:

Do not put anything on the ignition stem and in the rectangular area. In case the fire is not burning in first ignition after arranging of logs set, please open the window on the device and check if the electrode is clear and also the rectangular area around electrode is clear too. Subsequently after check repeat the ignition with opened window. When the fire burns evenly over the entire length of burners included secondary burners, the door can be closed. Repeat ignition one more time with closed window.



The illustration below is the position plane in a 1050DC.

For smaller models, place block 6,7,10 and 11 plus in the center with 8 and 9 in a slightly more vertical position.

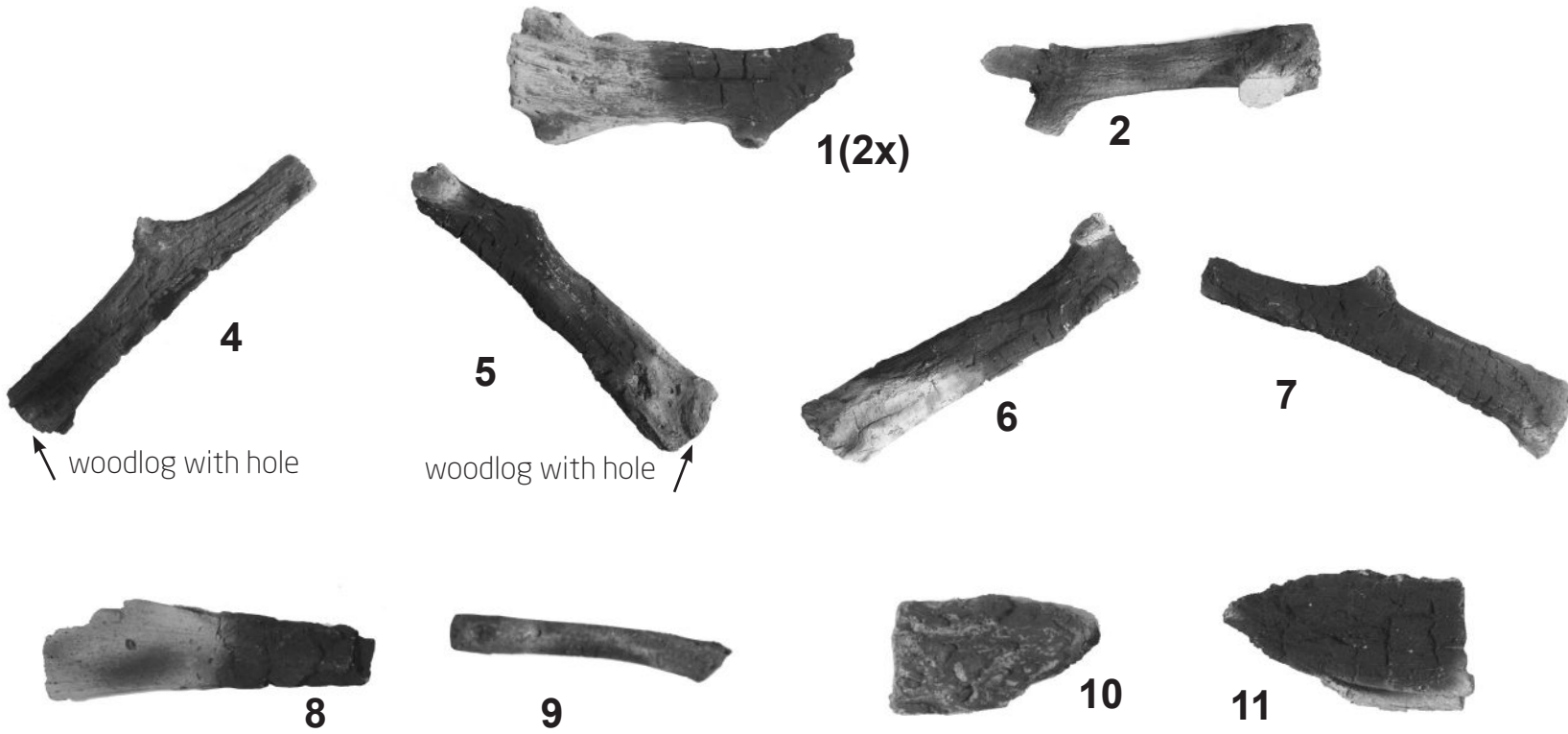

Block 1

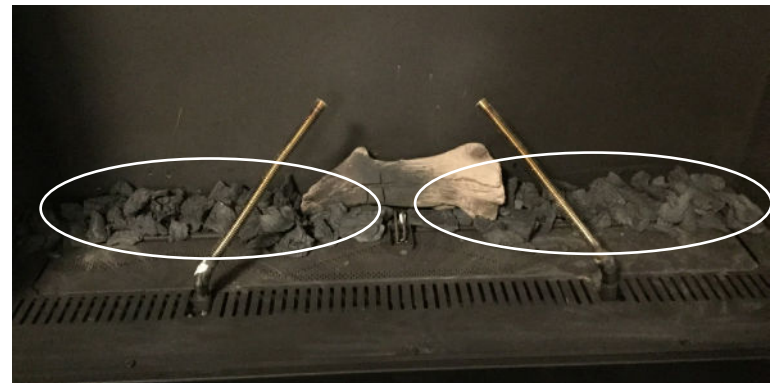

Lay a part of the imitation coal according to the photo.

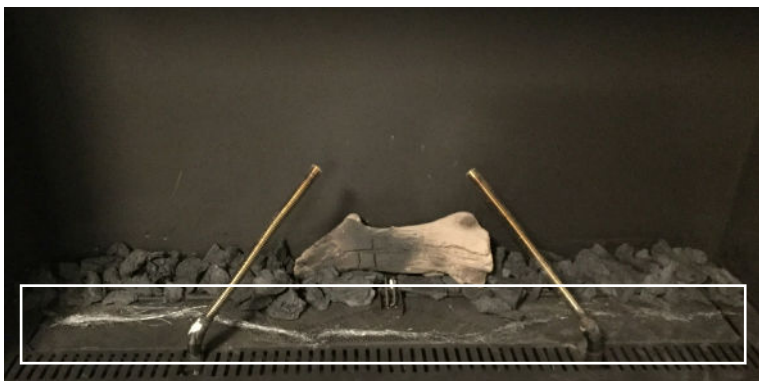

The "angel's hair" must be disentangled in length and deposit along the length of the burner according to the picture above.

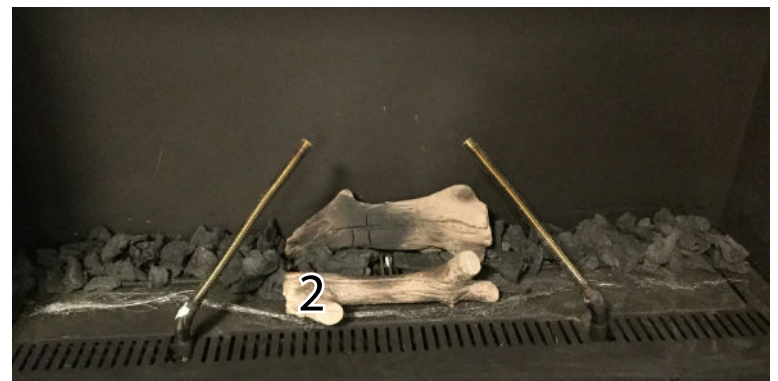

Block 2

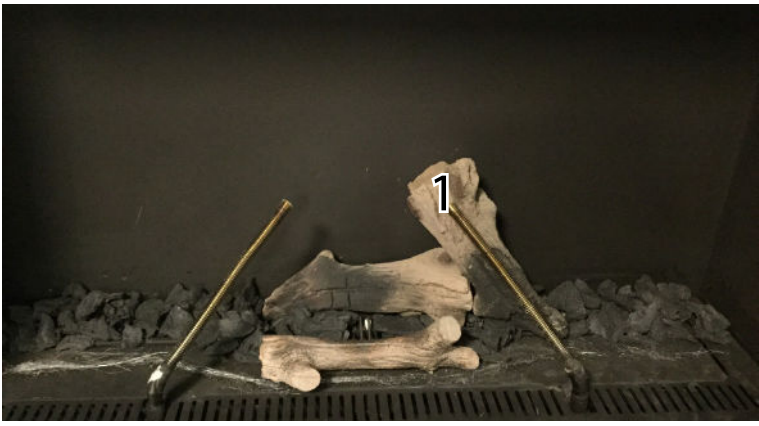

Block 1

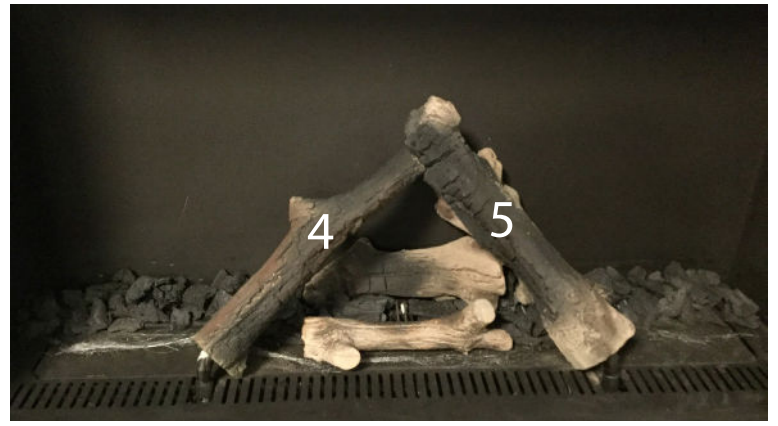

Slide block 4 and 5 (with holes) on the flexible burners

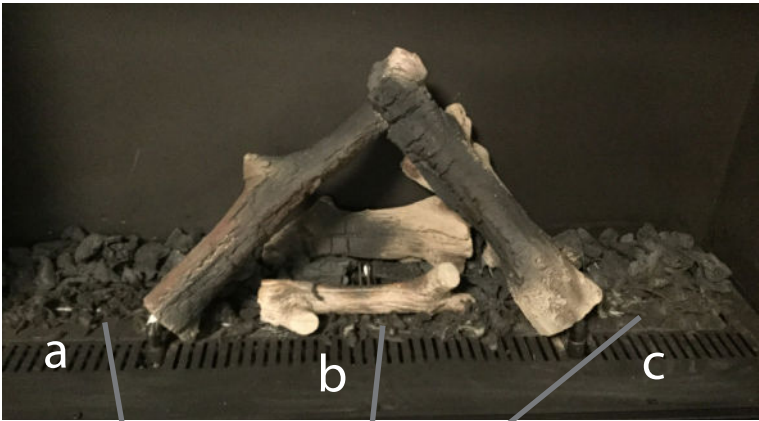

Put the glass wool on the "angel's hair" (see detail a,b and c)



a

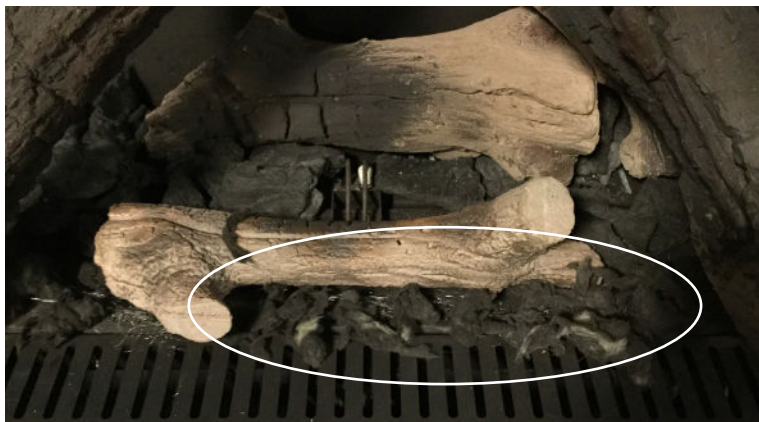

b



c



Put the rest of the imitation coal according to the photo.



Block 6



Block 7

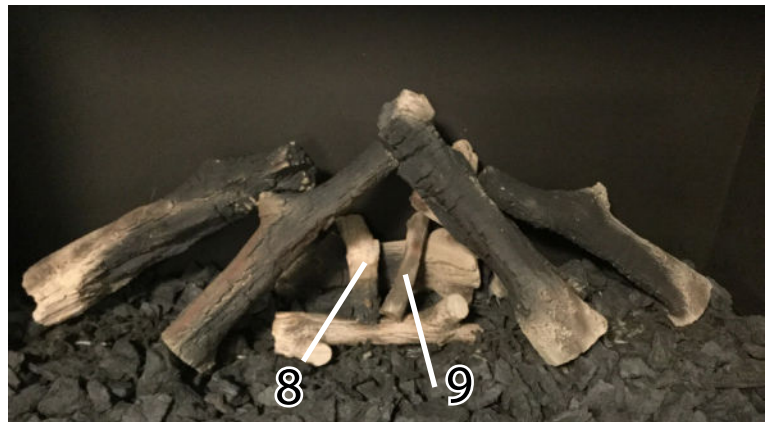

Block 8

Block 9



Block 10

Block 11

Woodset True Vision : SET H1 (for 550V)



Angel's hair (unex glow)
+ 5 packets Imitation coal

WARNING:
Do not put anything on the ignition stem and in the rectangular area. In case the fire is not burning in first ignition after arranging of logs set, please open the window on the device and check if the electrode is clear and also the rectangular area around electrode is clear too. Subsequently after check repeat the ignition with opened window. When the fire burns evenly over the entire length of burners included secondary burners, the door can be closed. Repeat ignition one more time with closed window.

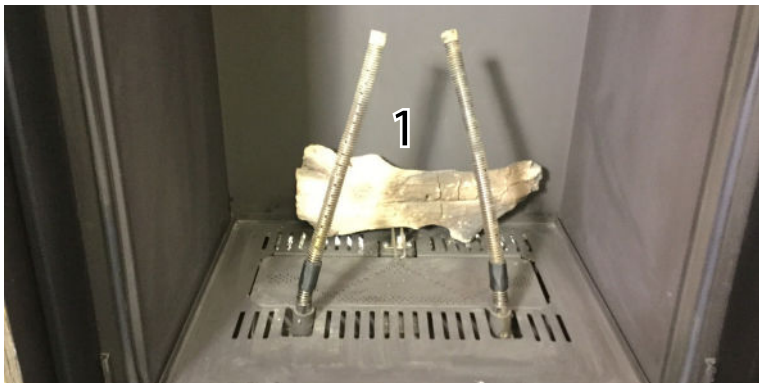
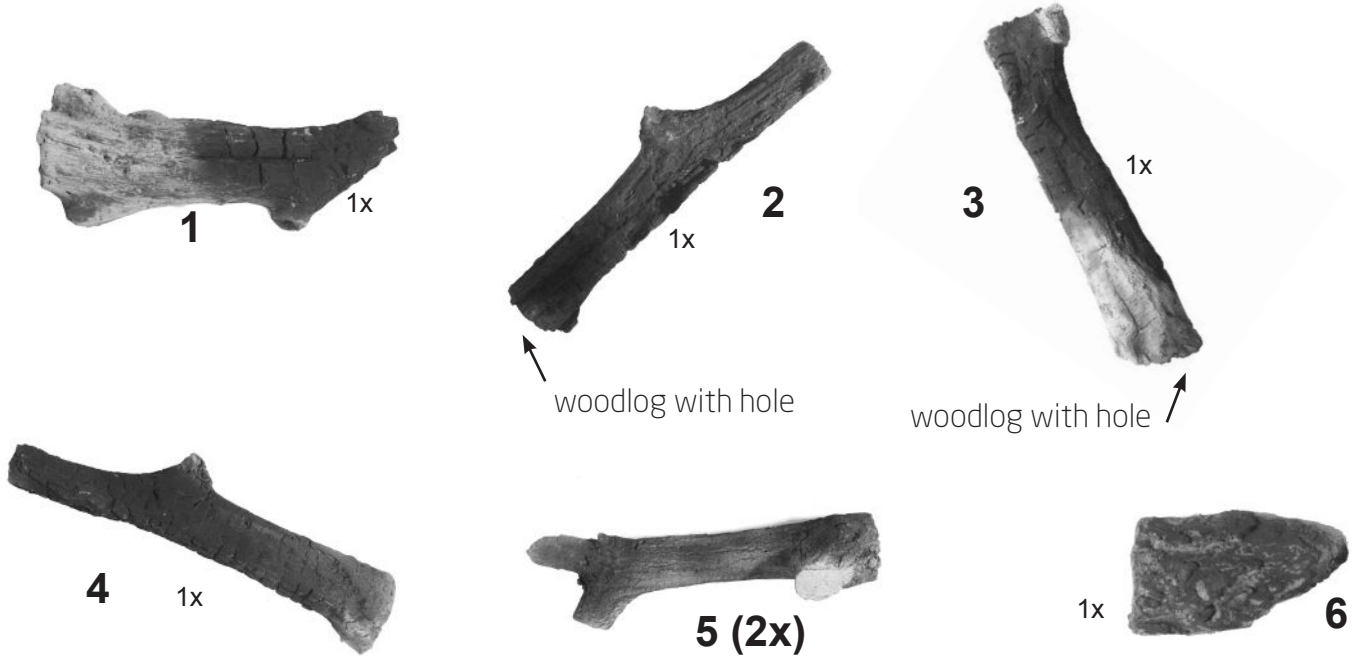

Block 1

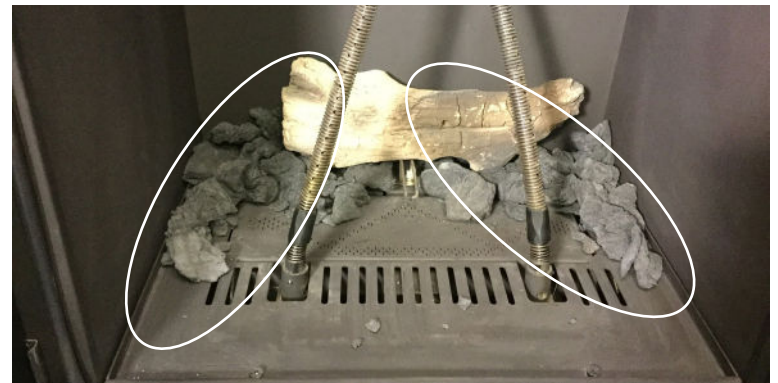

Lay a part of the imitation coal according to the photo.



blok 2,3 and 4



The "angel's hair" must be disentangled in length and deposit along the length of the burner according to the picture above.

Slide block 2,3 (with holes) on the flexible burner. Place block 4 at same time.



Put the glass wool on the "angel's hair"



Put the rest of the imitation coal according to the photo.



Block 5



Block 5



Block 6

Woodset True Vision : SET H2 (not for 550V and 1300V)

WARNING:

Do not put anything on the ignition stem and in the rectangular area. In case the fire is not burning in first ignition after arranging of logs set, please open the window on the device and check if the electrode is clear and also the rectangular area around electrode is clear too. Subsequently after check repeat the ignition with opened window. When the fire burns evenly over the entire length of burners included secondary burners, the door can be closed. Repeat ignition one more time with closed window.



Angel's hair (unex glow)
+ 5 packets Imitation coal

The illustration below is the position plan in an 850DC. For smaller models, place block 5 and 6 more towards the center.

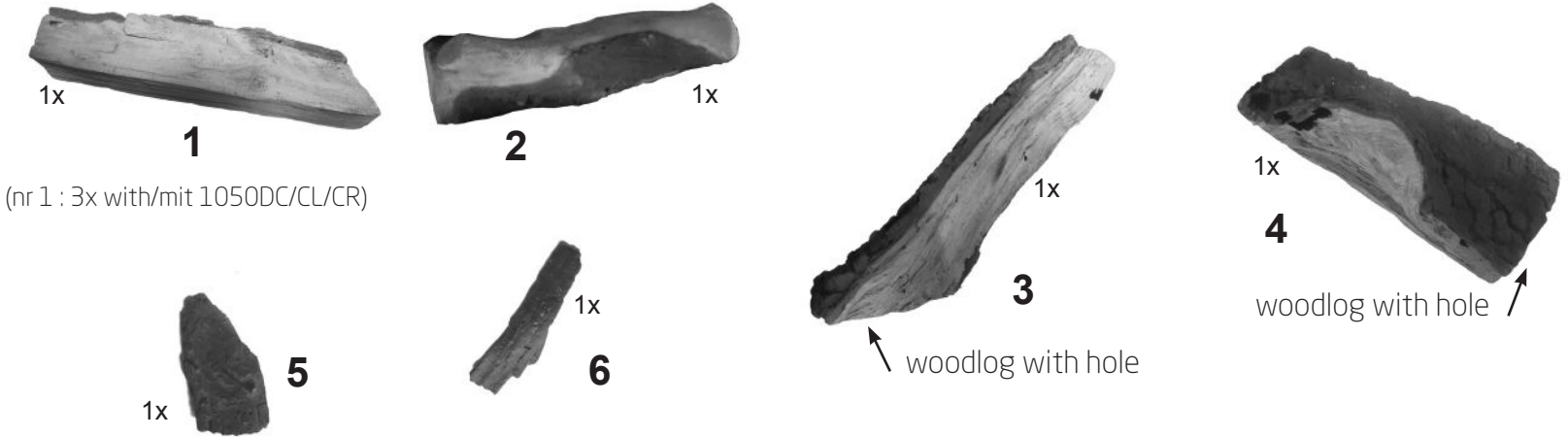

Lay a part of the imitation coal according to the photo.



The "angel's hair" must be disentangled in length and deposit along the length of the burner according to the picture above.

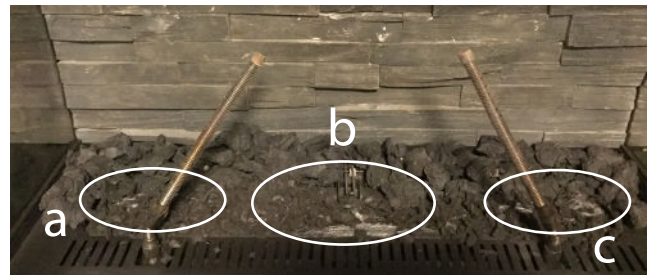

Put the glass wool on the "angel's hair" (see detail a,b and c)

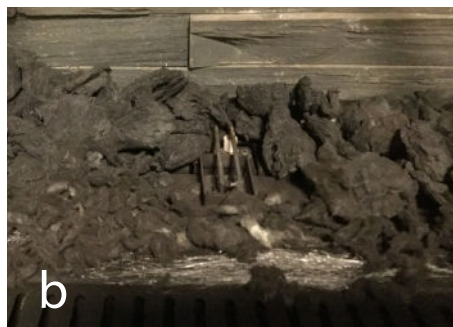

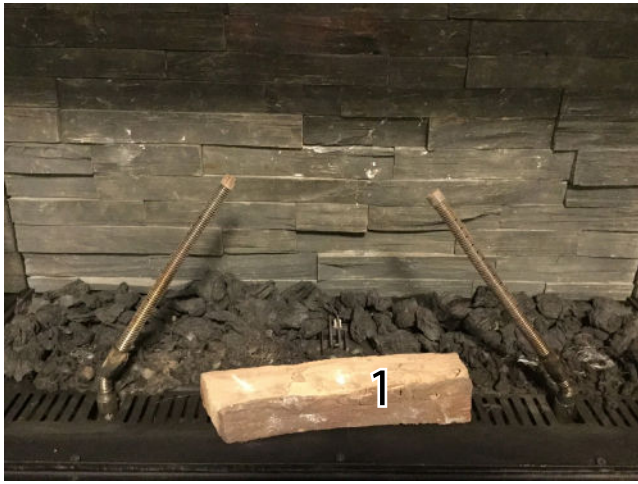

Block 1



Block 2



Slide block 3 and 4 (with holes) on the flexible burners

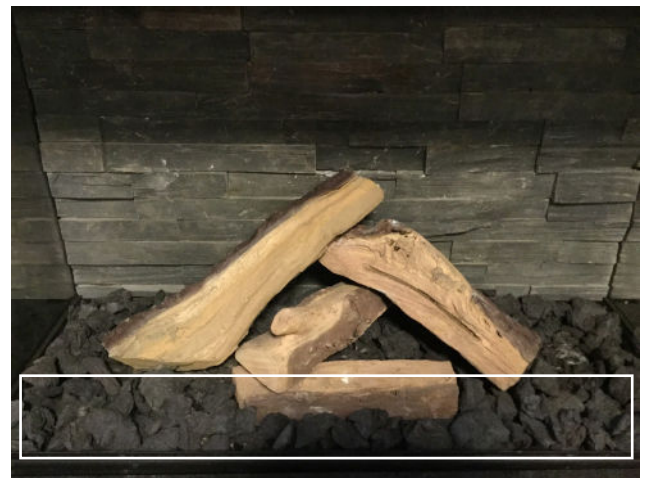

Put the rest of the imitation coal according to the photo.



Block 5 & 6



2 extra blocks nr 1 for the 1050 models

Woodset True Vision : SET H3 (only for 1300V)

WARNING:
Do not put anything on the ignition stem and in the rectangular area. In case the fire is not burning in first ignition after arranging of logs set, please open the window on the device and check if the electrode is clear and also the rectangular area around electrode is clear too. Subsequently after check repeat the ignition with opened window. When the fire burns evenly over the entire length of burners included secondary burners, the door can be closed. Repeat ignition one more time with closed window.



Angel's hair (unex glow)
+ 5 packets Imitation coal
glass wool (black)

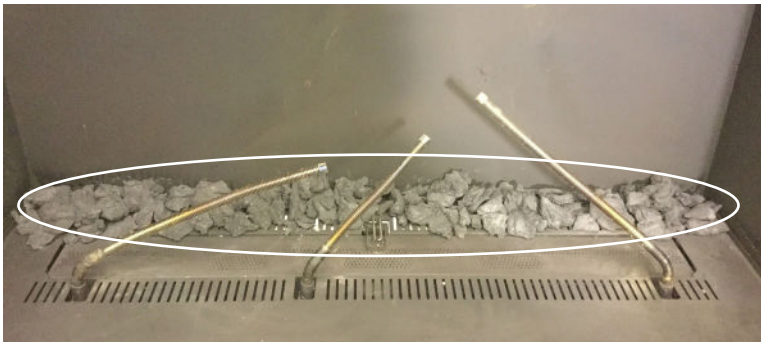
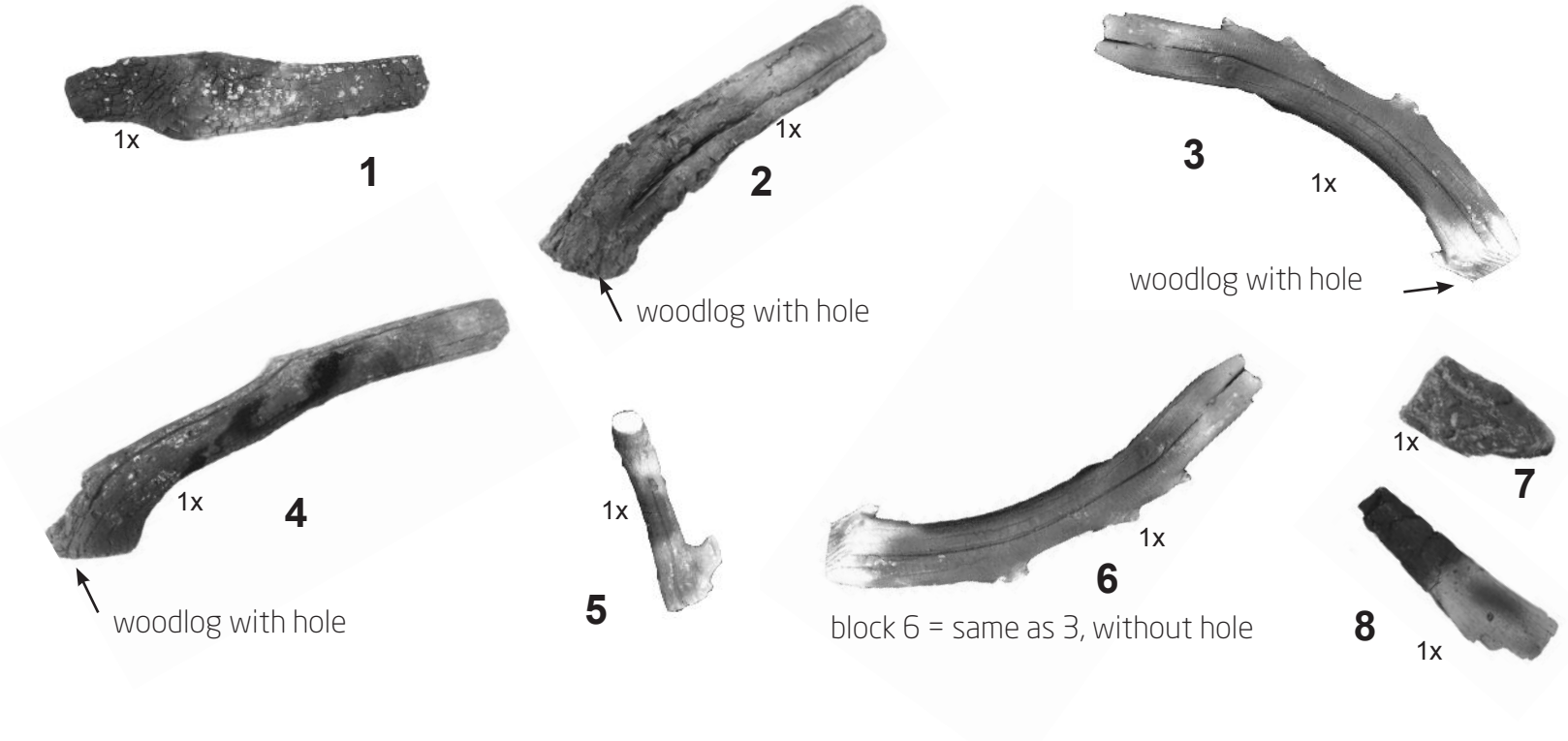

Lay a part of the imitation coal according to the photo.

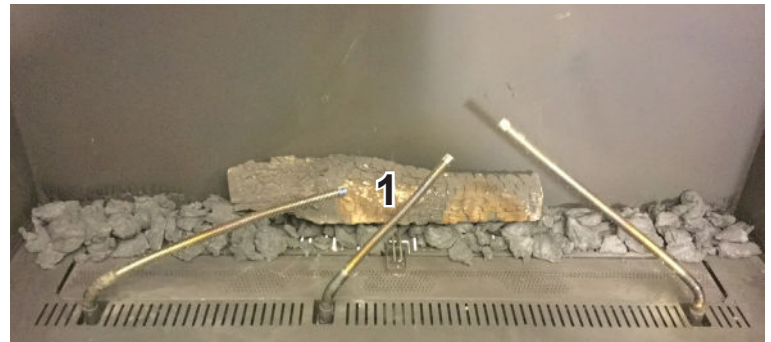

Block 1



The "angel's hair" must be disentangled in length and deposit along the length of the burner according to the picture above.

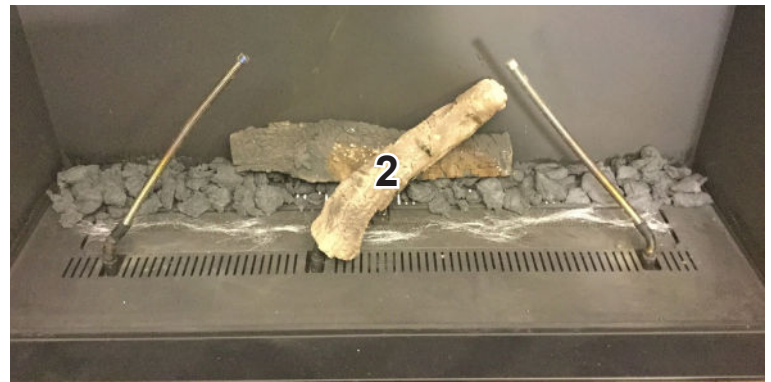

Slide block 2 (with holes) on the flexible burners



Slide block 3 (with holes) on the flexible burners



Slide block 4 (with holes) on the flexible burners



Put the rest of the imitation coal according to the photo.



Put the glass wool on the "angel's hair"



Block 5



Block 6



Block 7 & 8



9. First-time user

The masonry and plaster surrounding a recently installed appliance holds a great deal of moisture, which must first evaporate before commissioning the appliance. If not, the plaster may crack or split. Ask your installer about the timescale to follow. The first time you use it, only make a moderate-sized fire.

The first few times the appliance is used, an unpleasant odour may be apparent.

It comes from the protective paintwork. These emissions are totally harmless. To quickly get rid of these odours, all you need to do is ventilate the room for a while.

After the first few fires, a light deposit may appear on the window. It comes from the paintwork. Once the appliance is cold you can get rid of this deposit by using M Design's Bio-Clean cleaning product. This product may be used later on for cleaning the window.

The appliance must not be used if the door no longer has a window or with the door open. If the window is broken or cracked, the appliance must not be used until the window has been replaced. Contact your M Design reseller.

10. Safety, device and maintenance

Have your appliance inspected every 2 years by a qualified technician.

Please observe the following points:

- Closed appliances produce intense heat, which means that all the surfaces of the external walls (metal, door frames and windows) become very hot once a certain temperature is reached. Make sure that young children do not touch the window; this could result in severe burns.

- The logs, ceramic pebbles, a Diamond set and a Sapphire set are delivered with the appliance. **Never put other objects in the flames!**

- Check that there is nothing on the ignition pin and that the imitation coal does not lie on the small openings of the burner. When starting up, make sure you see the ignition sparks.

- **If after 2 attempts the device does not start up, wait 15 minutes before restarting, or open the window to attempt to start up. If this does not work, please contact the dealer and not try to get the device started.**

- Keep inflammable materials a suitable distance from the appliance (min. 1m)!

- Never modify the settings yourself! The furnace warranty will then be considered as invalid, null and void.

- Never let children use the remote control without supervision.

- If the burner goes out for any reason, wait at least three minutes before lighting the appliance again. Open the window to vent the fireplace.



11. Guarantee

This page is your warranty card.

The guarantee is only valid for faults caused by construction defects or defects in the parts used to build the appliance.

M-Design offers a 12 month guarantee on all electronic parts and a 8 year guarantee on the appliance construction.

Caution: The following items are always excluded from the guarantee:

- The glass, door, joints and internal decor.
- The defects which occur are fully or partially a consequence of
- Non respect of the order, installation and maintenance instructions
- Assembly, installation or repair by a third-party, including the buyer
- Heat cracks which normally occur in the mantel
- In cases where changes have been made to the appliance without our consent
- In cases where the buyer cannot show his/her warranty card with the purchase invoice.

Likewise where the guarantee and/or the invoice show(s) signs of tampering or forgery (crossed out date, illegible, modifications).

In the case you would like to make use of the manufacturer's warranty, you should contact your reseller in the first instance. Please take good care of your purchase invoice and warranty card and store them in a safe place.

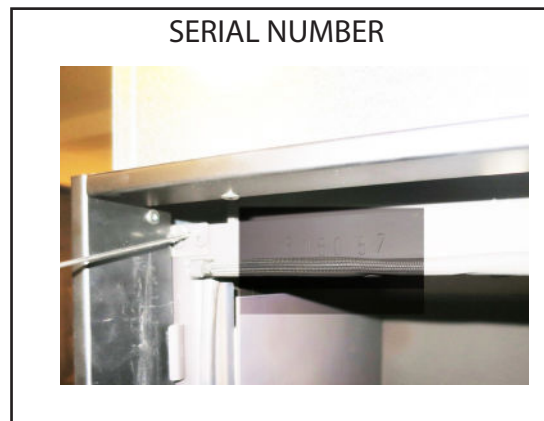



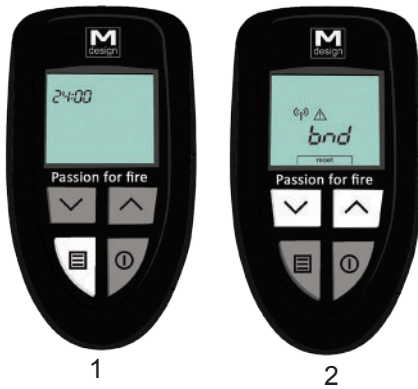

<p>Identification board</p> <p>SERIAL NUMBER :</p> <p>.....</p>	
--	--

12. Remote control (direct ignition)



1. First use (Connect the remote control)



Keep pressing the button  until 24:00 appears in the top left corner (1).
Press several times on  until you see "bnd" on the screen (2)
Press shortly on  and 
You see the temperature on the screen. Your remote control is now connected.

2. Ignite the fire



Press simultaneously on  and 

You hear the ionisation pen ticking.
The ticking lasts for about 15 sec.
At initial setup, it's possible that the pilot flame doesn't ignite immediately because the pipes are not yet fully deflated.
You can try this up to 5 times before the unit will be placed in safety. If this fails, please contact your installer.

3. Manual control



From the moment the burner 1 is on, you can start with the flame height control.

The screen will automatically show manual control (flame height control)

Press on  until you see number 15.

This is the maximum flame height.

Choose a flame height from 1 to 15

by pressing  or 

2. Second burners

1. Main burner

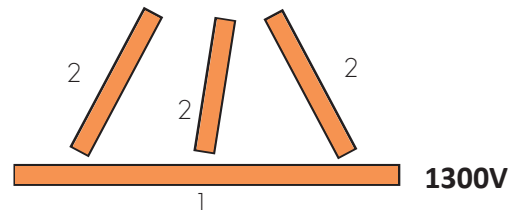
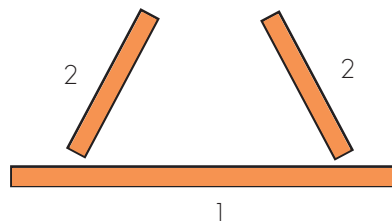

3. Manual control (continuation) **ECO SWITCH**



1

2



3

4

To light up the side burners 2, press .

First you see the wave settings (page 30).  or 

Press a second time  and you will see a "b0" or "b0"

Remark: If after a previous use of the fireplace, you turned it off in "b1" mode, next ignition, the burners 1,2 and 3 will light simultaneously. If, on the other hand, you have switched off the appliance in mode "b0" the appliance will switch on only with the burner 1

If "b0" appears, press  to "b1", side burners 2 lights up.

If "b1" appears, press  to "b0", side burners 2 will go out.

Choose a flame height from 1 to 15 by pressing  or 

To switch off the entire stove press 

4. Thermostatic control

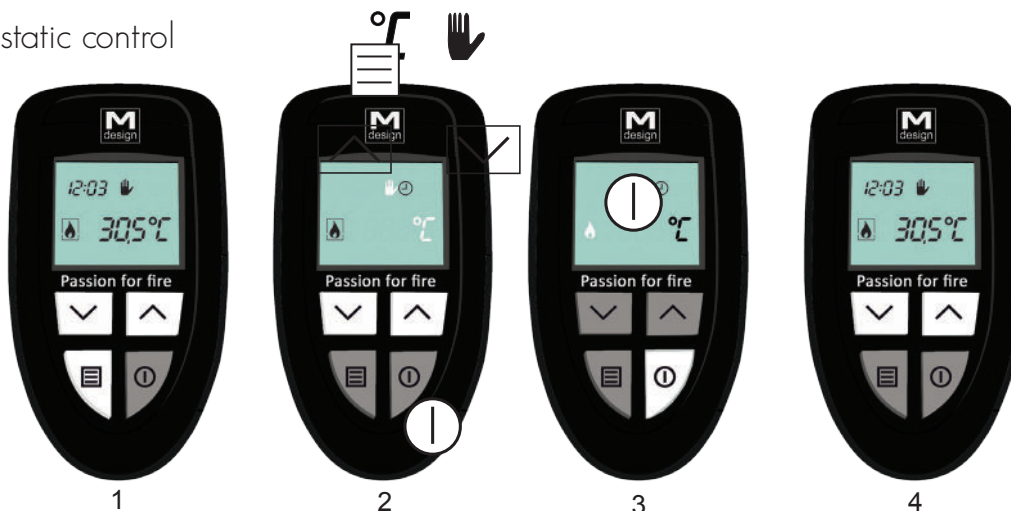

In case you want to go to a thermostatic control, you follow the next steps:



Press 2x  the button until you see the screen with the symbols shown in picture 2.

Press  or  until the symbols  and  are blinking (pic 2).

Confirm your choice by pressing  (pic.3).

Choose a temperature with the "up" and "down" arrows (pic. 4).

Don't place the remote control near the fire. The temperature sensor is in the remote

control. To get back to manual control do the same until  and  are blinking.

Confirm with 

5. ECO WAVE

ECO WAVE : each model is standard delivered with ECO-WAVE

ECO-WAVE is an automatic cycle of fluctuating flames.

At each start-up of the fire, the system starts in ECO-WAVE mode !

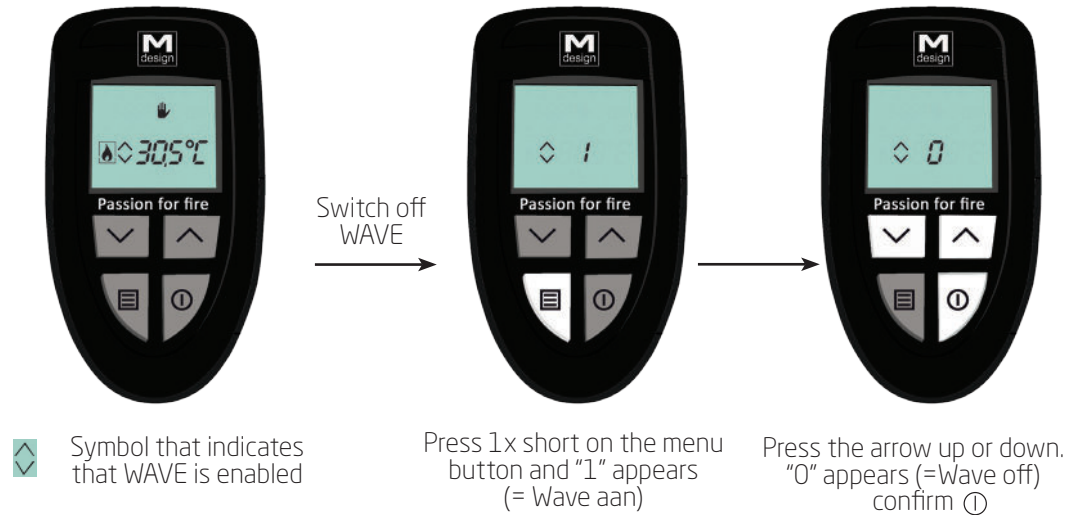

Shut down fire :

Press 1 x ① to turn off the fireplace. The fireplace will start-up with 1 or multiple burners depending on the "b" position.

Press 2x on the menu button to see whether the fire is set to "0" or "1" position.

	TECHNICKÝ SKÚŠOBNÝ ÚSTAV PIEŠŤANY, š.p. Krajinská cesta 2929/9 921 01 Piešťany, Slovenská republika Notifikovaná osoba č. 1299	
CERTIFIKÁT ES SKÚŠKY TYPU EC TYPE - EXAMINATION CERTIFICATE №./No. 161299190		
pre výrobcu alebo jeho autorizovaného zástupcu v Európskej únii to the manufacturer or his authorised representative in the European Union		
M – Design Central Europe, s.r.o. Podhorie 71, 013 18 Podhorie Slovenská republika / Slovak Republic		
Výrobok a určenie typu Uzavreté krbové vložky. na plynné palivá, zhotovenie „B₁₁“; „C₁₁“; „C₃₁“; „C₉₁“ typy: podľa prílohy	Product and designation of type Closed Gas Stoves burning gaseous fuels, type „B₁₁“; „C₁₁“; „C₃₁“; „C₉₁“ models: According to Annex	
špecifikácia je uvedená na druhej strane Identifikačné číslo výrobku: CE-1299CR0190	specification is stated on the back page Product ID Number: CE-1299CR0190	
Preskúšaná vzorka spĺňa základné požiadavky na bezpečnosť podľa nasledujúcich európskych smerníc Nového prístupu: 2009/142/EC týkajúcej sa spotrebičov spaľujúcich plynné palivá Certifikát bol vydaný na základe nasledujúcich dokumentov: Správa o posúdení zhody č. 140500126/4 zo dňa 03.10.2016	The tested sample meets the essential safety requirements of the following European New Approach Directives : 2009/142/EC relating to appliances burning gaseous fuels Certificate is issued on the basis of this document: Report of assessment conformity procedure No. 140500126/4 Date of issue on 03 October 2016	
CE označenie môže byť použité iba v prípade, že je posúdená zhoda so všetkými príslušnými smernicami Európskej komisie. Akékoľvek významné zmeny v zhotovení alebo konštrukcii výrobku, systéme kvality a dodatky k horeuvedeným technickým a právny predpisom môžu viesť k neplatnosti certifikátu. Zodpovednosť za výrobok zostáva na výrobcovi alebo jeho splnomocnenom zástupcovi	CE mark can be used only in the case of conformity assessment according to all relevant Directives of the European Commission. Any significant change in product's form or construction, system of quality and supplements to above mentioned technical and legal provisions can result in invalidity of the certificate. Producer or his representative is responsible for the product.	
Vydaný dňa: 04.10.2016 Date of issue: on 04 October 2016		 Ing. Dušan Hanko za TSU Piešťany, š.p., Notifikovanú osobu 1299 on behalf of TSU Piešťany, s.p., Notified Body 1299

Krajiny určenia (Countries of destination)	Používané pripojovacie tlaky (Supply pressures)	Kategória spotrebiča (Appliances categories)
AT Austria	20 mbar 50 mbar	H _{2000F}
BE Belgium	20/25 mbar, 50 mbar, 28-30/37 mbar	L ₂₀₀ , L ₃₀ , L _{3F}
BG Bulgaria	20 mbar, 29-30 mbar	H _{2000F}
CH Switzerland	20 mbar, 50 mbar, 28-30/37 mbar	H _{2000F} , H ₂₀₀₊ , H _{200F}
CZ Czech Republic	20 mbar, 50 mbar, 37 mbar	H _{2000F} , H _{200F}
DE Germany	20 mbar, 50 mbar, 28-30 mbar	H _{2000F}
DK Denmark	20 mbar, 30 mbar	H _{2000F}
EE Estonia	20 mbar, 29-30 mbar	H _{2000F}
ES Spain	20 mbar, 37 mbar, 50 mbar, 28-30/37 mbar	H ₂₀₀ , H _{200F}
FI Finland	20 mbar, 28-30 mbar,	H _{2000F}
FR France	20/25 mbar, 28-30 mbar, 50 mbar, 37 mbar, 50 mbar, 28-30/37 mbar	H ₂₀₀ , H _{200F}
GB Great Britain	20 mbar, 28-30 mbar, 37 mbar, 50 mbar, 28-30/37 mbar	H ₂₀₀ , H _{200F}
GR Greece	20 mbar, 30 mbar, 37 mbar, 50 mbar, 28-30/37 mbar	H _{2000F} , H _{200F} , H ₂₀₀₊
HU Hungary	25 mbar, 28-30 mbar, 50 mbar	H _{2000F} , H _{200F}
IE Ireland	20 mbar, 28-30 mbar, 37 mbar 28-30/37 mbar	H ₂₀₀ , H _{200F}
IT Italy	20 mbar, 28-30/37 mbar	H ₂₀₀₊
LT Lithuania	20 mbar, 29-30 mbar	H _{2000F}
LV Latvia	20 mbar, 29-30 mbar	H _{2000F}
NL the Netherlands	25 mbar, 30-50 mbar	H _{2000F} , H _{200F}
NO Norway	29-30 mbar	L _{300F}
PL Poland	29-30 mbar	L _{300F}
PT Portugal	20 mbar, 29-30 mbar, 37 mbar, 28-30/37 mbar	H ₂₀₀ , H _{200F}
RO Romania	20 mbar, 29-30 mbar, 37 mbar	H _{2000F} , H _{200F}
SK Slovakia	20 mbar, 37 mbar, 28-30/37 mbar, 50 mbar	H _{2000F} , H ₂₀₀ , H _{200F}
SI Slovenia	20 mbar, 29-30 mbar	H _{2000F} , H ₂₀₀ , H _{200F}
SE Sweden	20 mbar, 28-30 mbar,	H _{2000F}

**Pravidlá pre používanie ES certifikátu skúšky typu.
The rules for use of this EC-type examination certificate.**

Je zakázané meniť, dopĺňovať alebo prepisovať údaje v ES certifikáte skúšky typu.
Tento certifikát nie je možné použiť ako ES certifikát skúšky typu pre výrobok, u ktorého bola vykonaná bez súhlasu TSÚ Piešťany, š.p. zmena, ovplyvňujúca zhodu s použitými normatívnymi dokumentmi a predpismi.
It is forbidden to modify, amend or rewrite the data in the EC type-examination certificate.
This certificate cannot be used as a EC type-examination certificate for product, where a change influencing conformity with the applied normative documents and regulations was done without approval of the TSÚ Piešťany, š.p.



081894

PRÍLOHA K CERTIFIKÁTU ES SKÚŠKY TYPU
ANNEX TO THE EC TYPE – EXAMINATION CERTIFICATE
№./No. 161299190

Str. 1/2

Uzavreté krbové vložky na plynné palivá (Closed Gas Stoves burning gaseous fuels)

Špecifikácia (Specification):

1. Uzavreté krbové vložky rady GAS H-TRUE VISION na plynné palivá, zhotovenie „B₁₁“; „C₁₁“; „C₃₁“; „C₉₁“
Closed Gas Stoves GAS H-TRUE VISION burning gaseous fuels, type: „B₁₁“; „C₁₁“; „C₃₁“; „C₉₁“
 modely (models):

650x450	950x450	1100x450	1250x450
1550x450	1850x450		

2. Uzavreté krbové vložky rady GAS V-TRUE VISION na plynné palivá, zhotovenie „B₁₁“; „C₁₁“; „C₃₁“; „C₉₁“
Closed Gas Stoves GAS V-TRUE VISION burning gaseous fuels, type: „B₁₁“; „C₁₁“; „C₃₁“; „C₉₁“
 modely (models):

800x660	950x660	1100x700	500x900
---------	---------	----------	---------

3. Uzavreté krbové vložky rady GAS DC-TRUE VISION na plynné palivá, zhotovenie „B₁₁“; „C₁₁“; „C₃₁“; „C₉₁“
Closed Gas Stoves GAS DC-TRUE VISION burning gaseous fuels, type: „B₁₁“; „C₁₁“; „C₃₁“; „C₉₁“
 modely (models):

650x550	850x550	900x450	1050x600
1050x450	1200x450	1500x450	

4. Uzavreté krbové vložky rady GAS CL/CR-TRUE VISION na plynné palivá, zhotovenie „B₁₁“; „C₁₁“; „C₃₁“; „C₉₁“
Closed Gas Stoves GAS CL/CR-TRUE VISION burning gaseous fuels, type: „B₁₁“; „C₁₁“; „C₃₁“; „C₉₁“
 modely (models):

850x550	950x450	1050x450	1050x600
1200x450	1500x450		

5. Uzavreté krbové vložky rady INTERRA na plynné palivá, zhotovenie „B₁₁“; „C₁₁“; „C₃₁“; „C₉₁“
Closed Gas Stoves INTERRA burning gaseous fuels, type: „B₁₁“; „C₁₁“; „C₃₁“; „C₉₁“
 modely (models):

INTERRA 60	INTERRA 68	INTERRA 74	INTERRA 78
------------	------------	------------	------------

6. Uzavreté krbové vložky rady Luna H/V Diamond na plynné palivá, zhotovenie „B₁₁“; „C₁₁“; „C₃₁“; „C₉₁“
Closed Gas Stoves Luna H/V Diamond burning gaseous fuels, type: „B₁₁“; „C₁₁“; „C₃₁“; „C₉₁“
 modely (models):

Luna 700 H Diamond	Luna 1000 H Diamond	Luna 1150 H Diamond	Luna 1300 H Diamond
Luna 1600 H Diamond	Luna 1900 H Diamond	Luna 550 V Diamond	Luna 850 V Diamond

7. Uzavreté krbové vložky rady Luna DH/DV Diamond na plynné palivá, zhotovenie „B₁₁“; „C₁₁“; „C₃₁“; „C₉₁“
Closed Gas Stoves Luna DH/DV Diamond burning gaseous fuels, type: „B₁₁“; „C₁₁“; „C₃₁“; „C₉₁“
 modely (models):

Luna 1000 DH Diamond	Luna 1150 DH Diamond	Luna 1300 DH Diamond	Luna 1600 DH Diamond
Luna 550 DV Diamond	Luna 850 DV Diamond		



14. Drawings

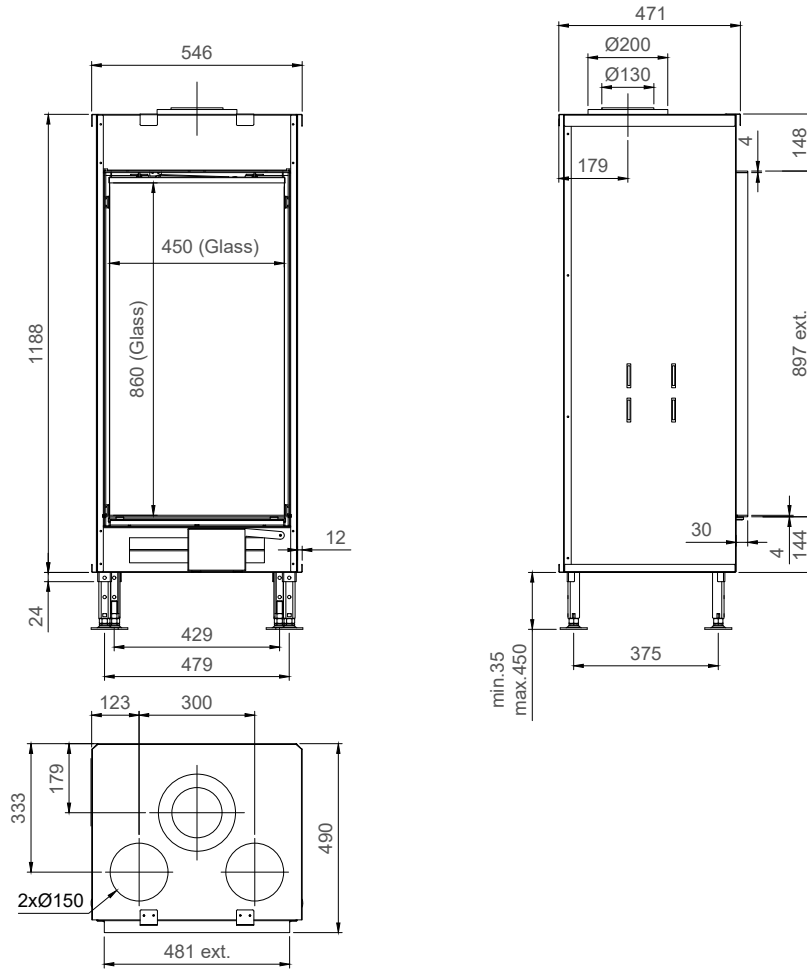

True Vision 550V

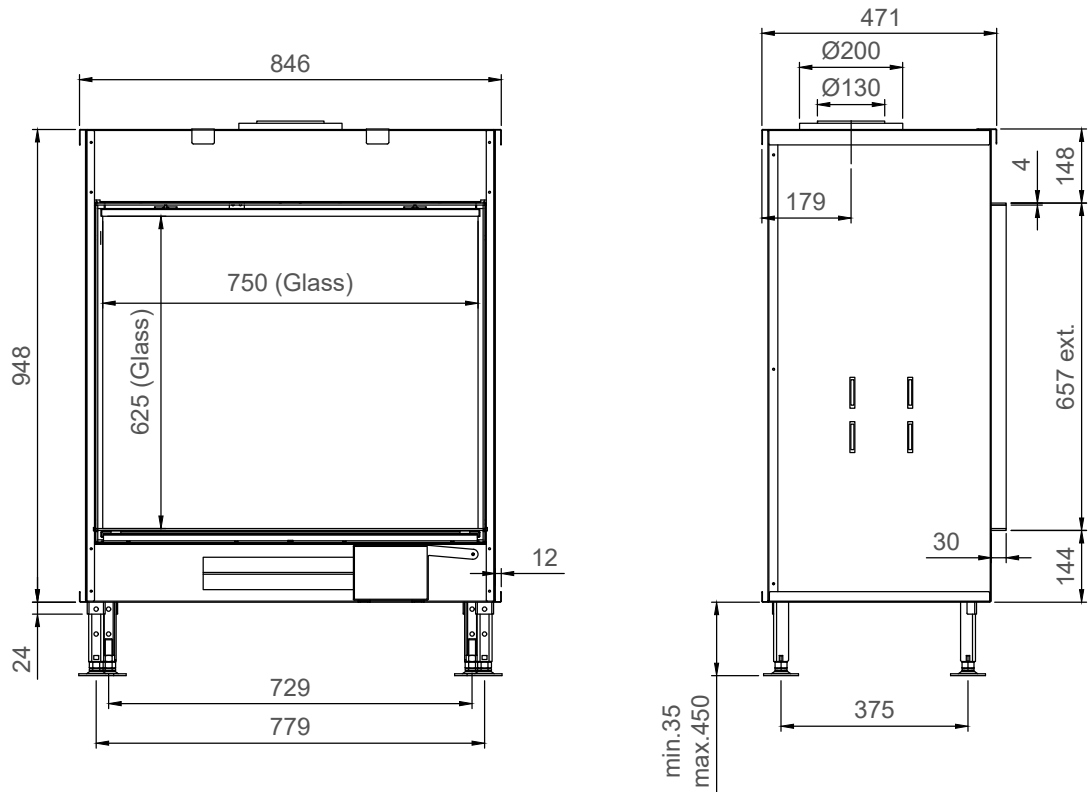

True Vision 850V

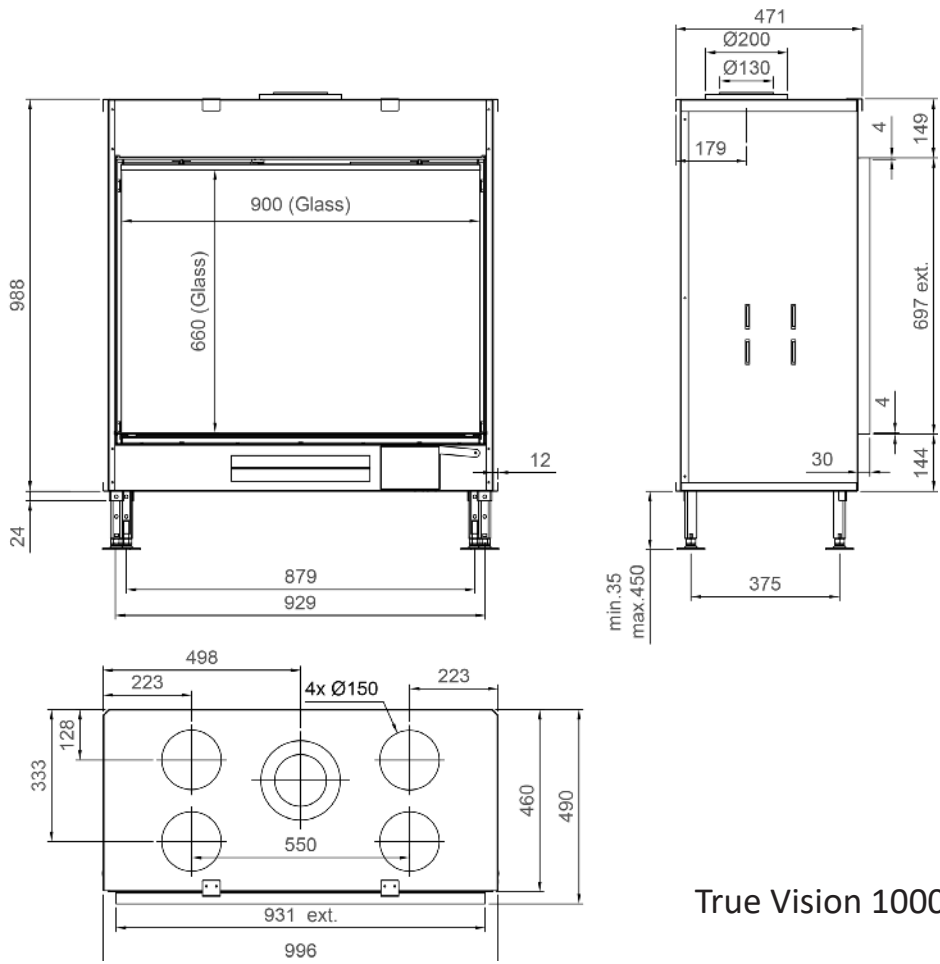

True Vision 1000V

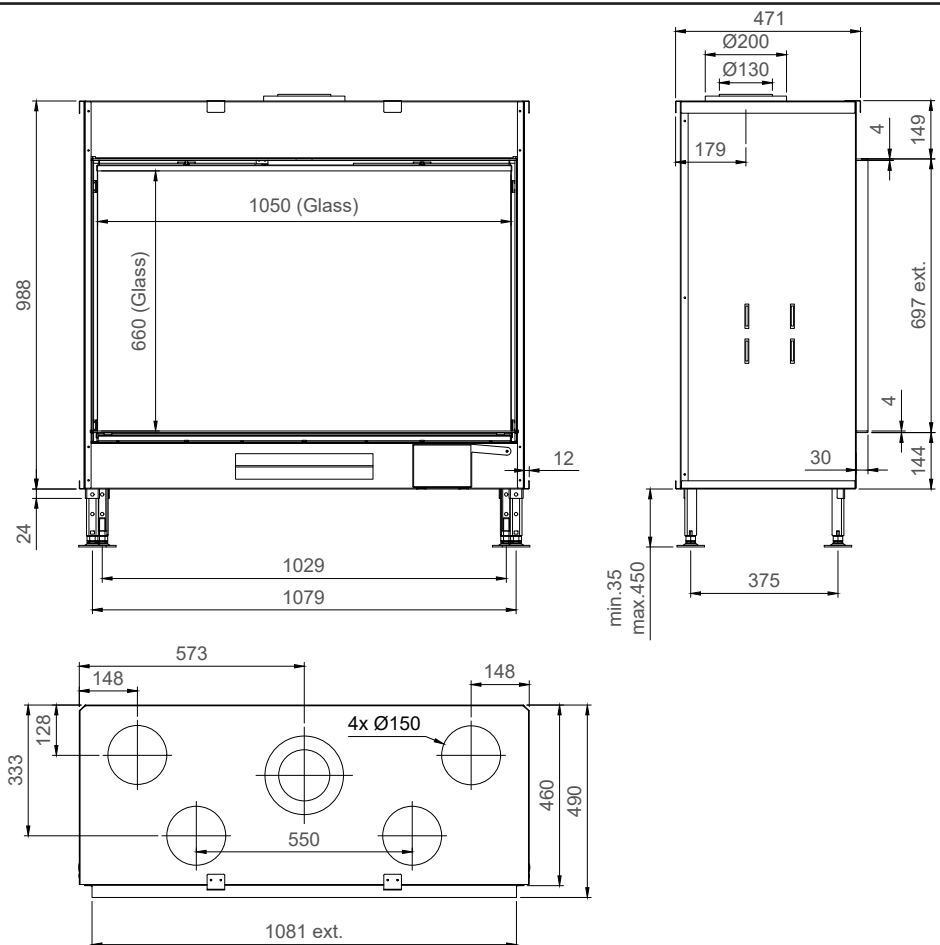

True Vision 1150V

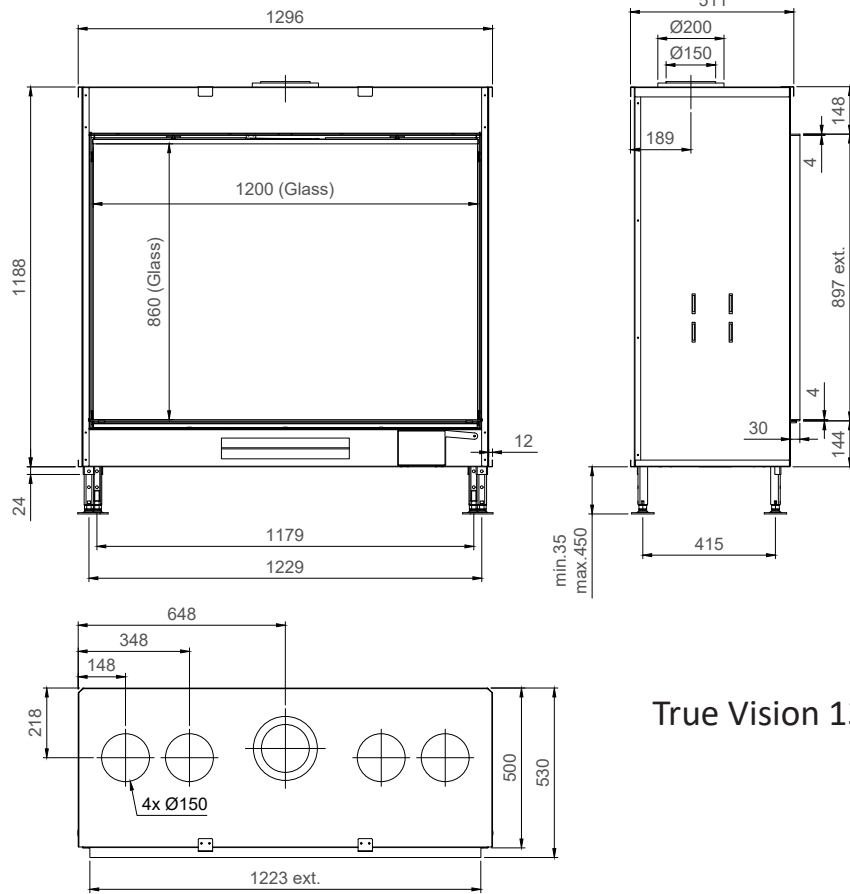

True Vision 1300V

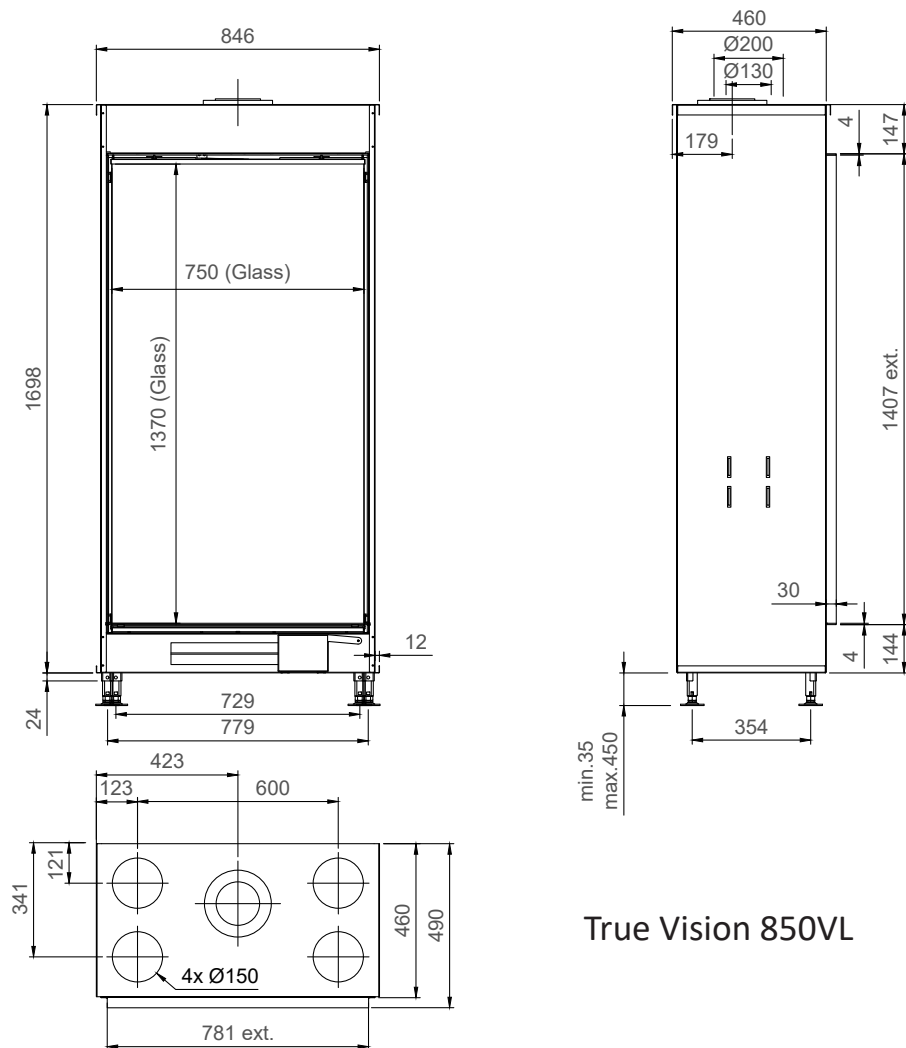

True Vision 850VL

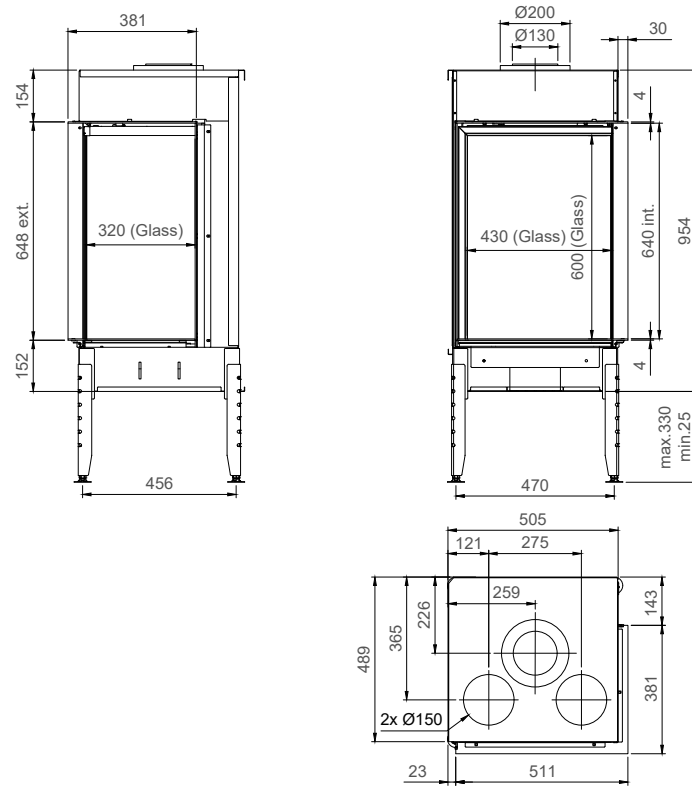

True Vision 550CL/CR

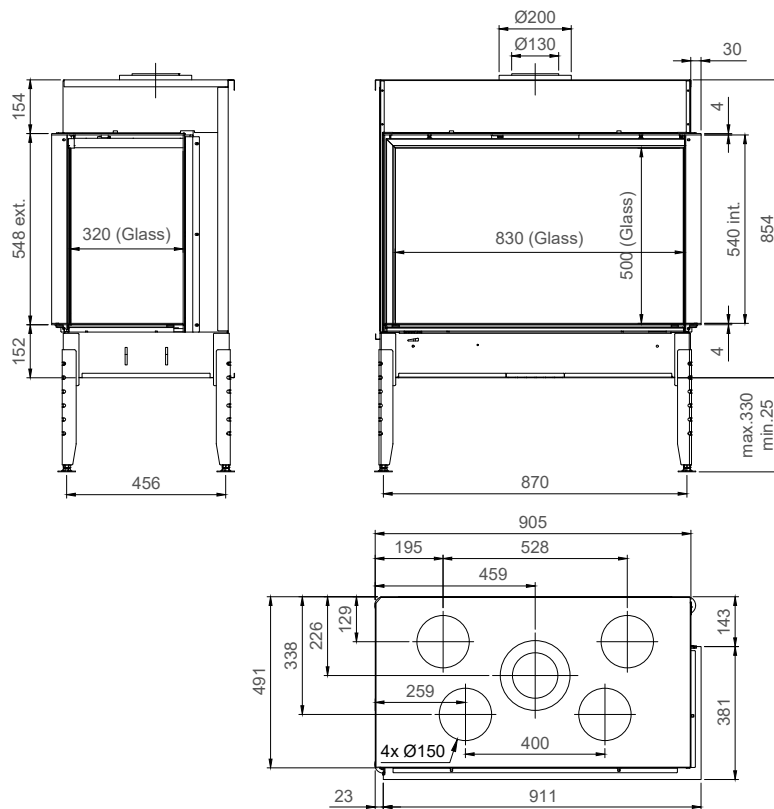

True Vision 850CL/CR

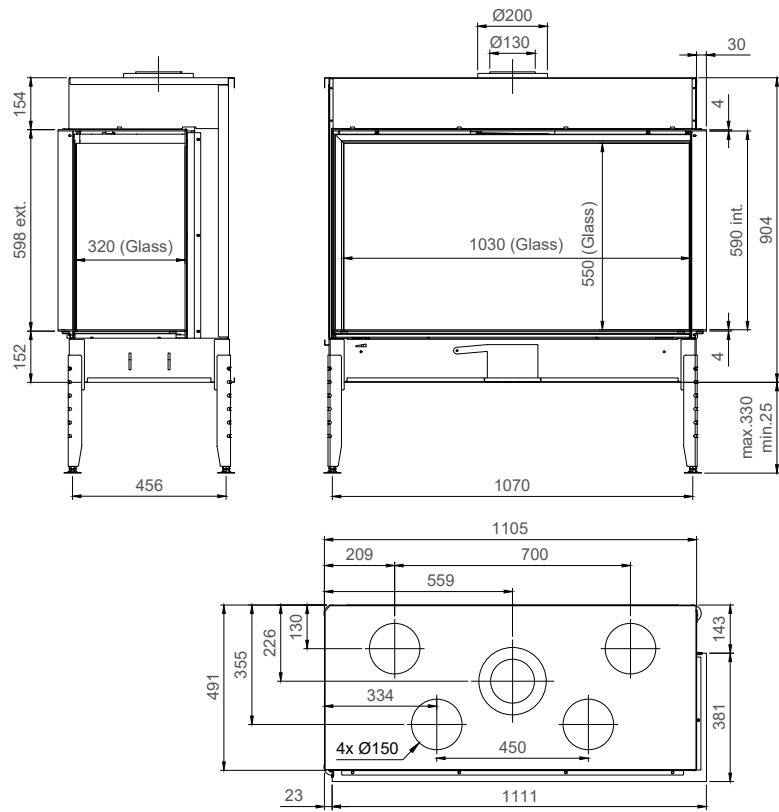

True Vision 1050CL/CR

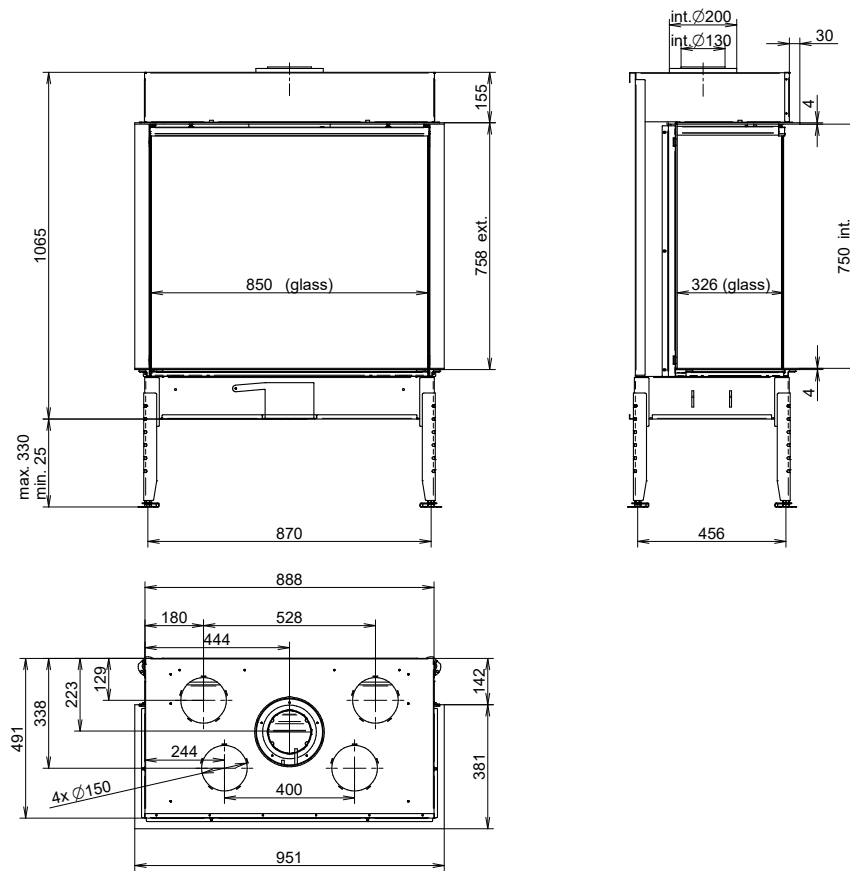

True Vision 850 VCL/CR

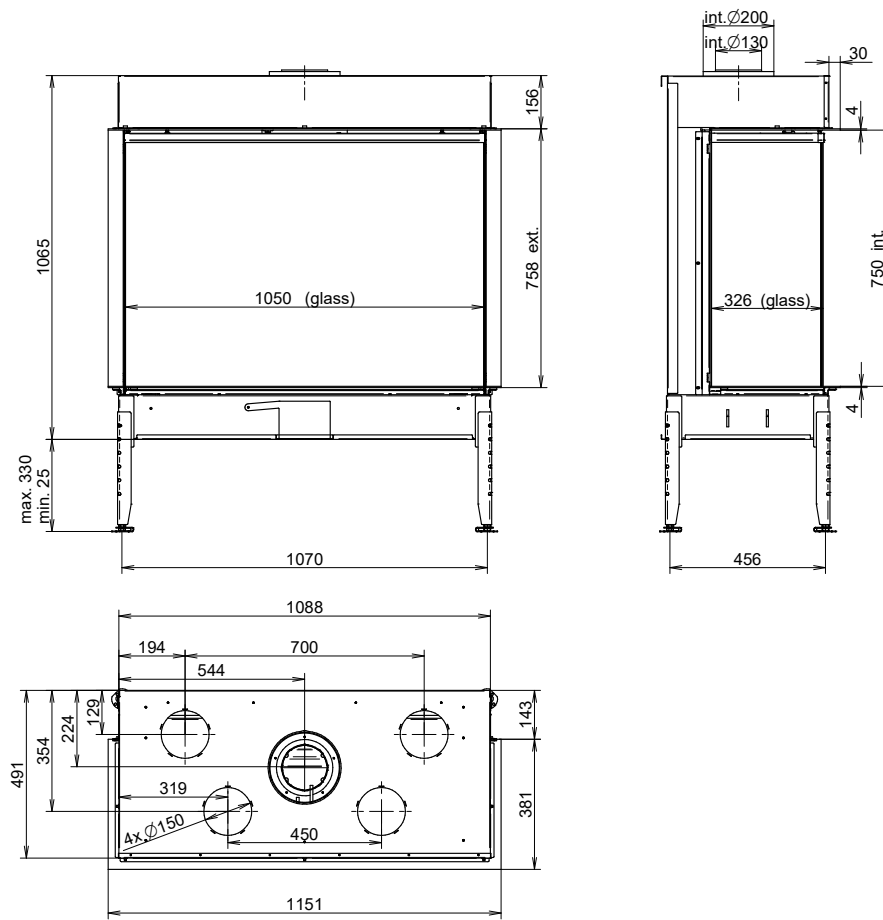

True Vision 1050 VCL/CR

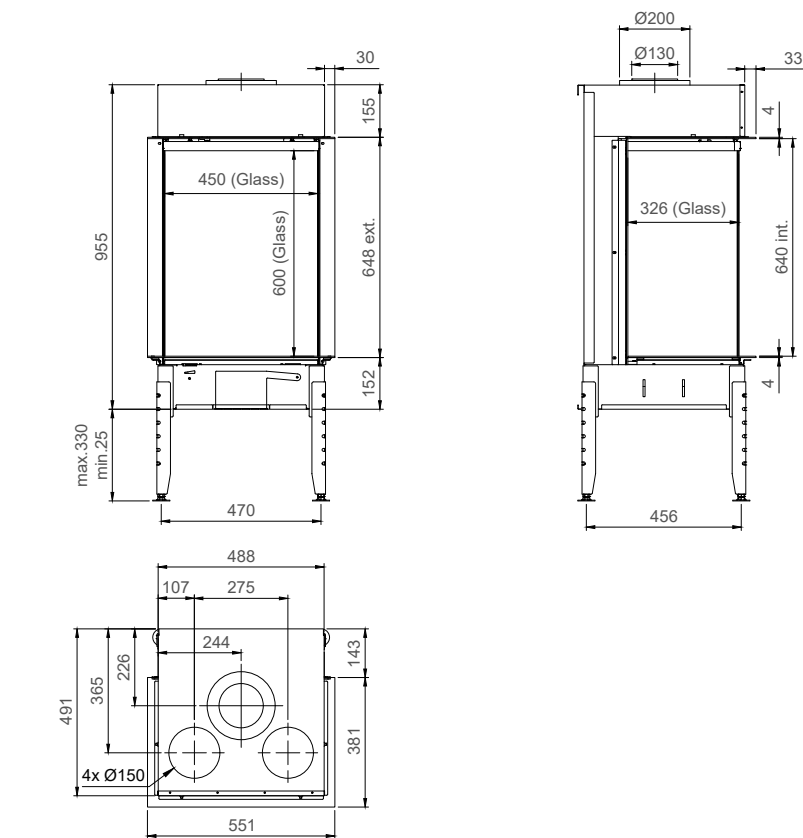

True Vision 550DC

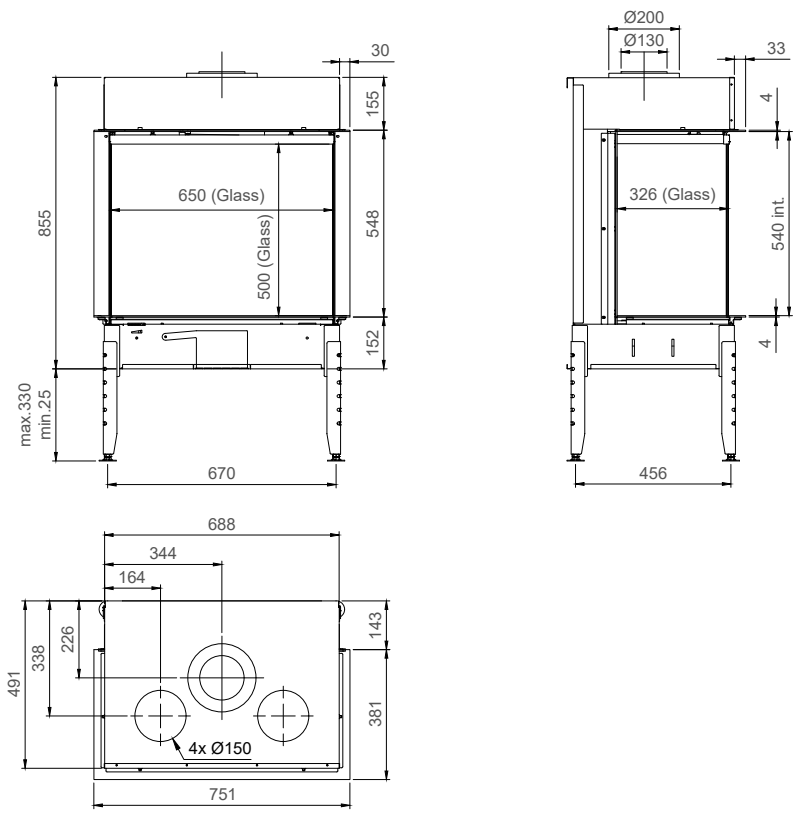

True Vision / Open Fire Look 650DC

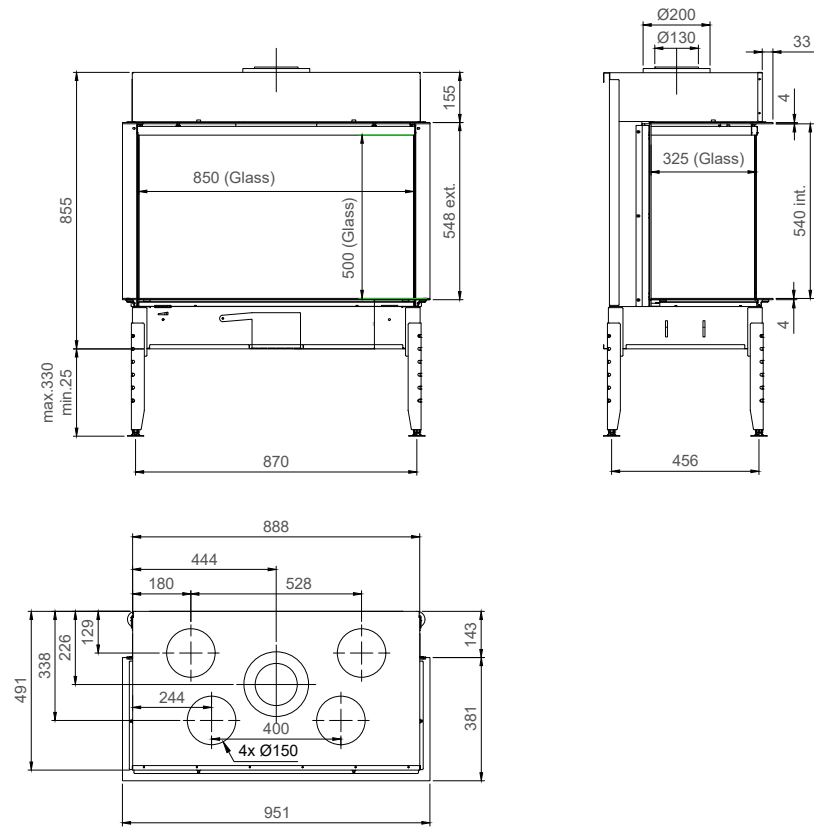

True Vision / Open Fire Look 850DC

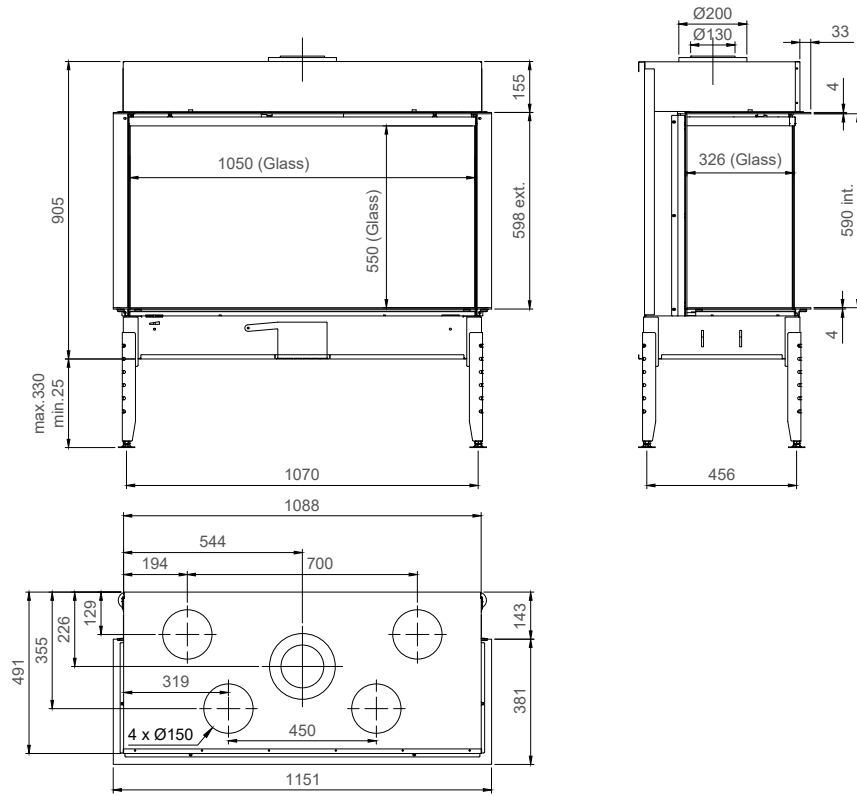

True Vision 1050DC

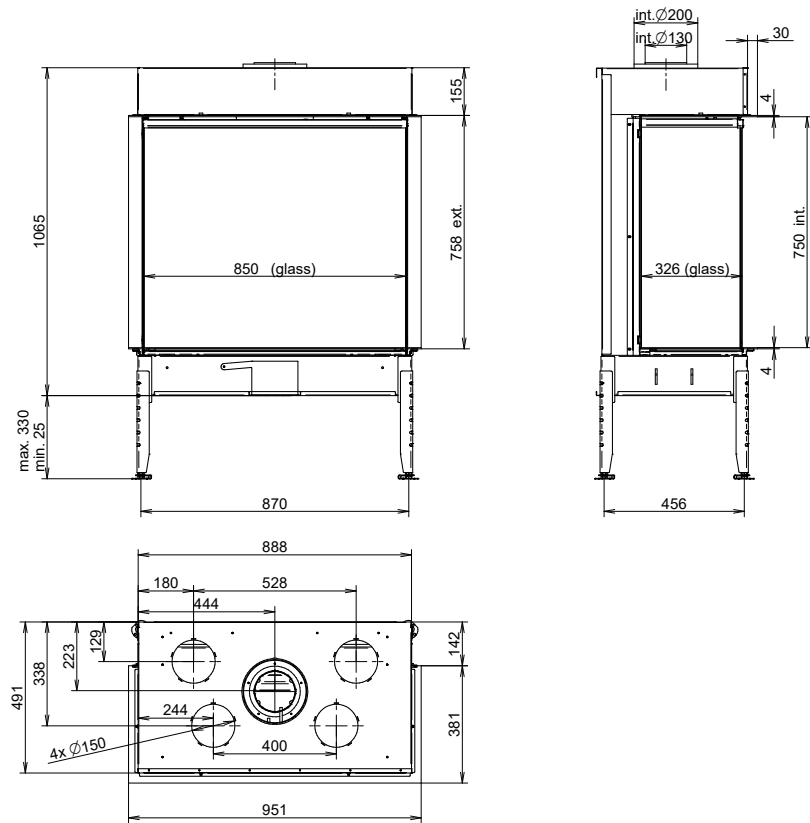

True Vision 850 VDC

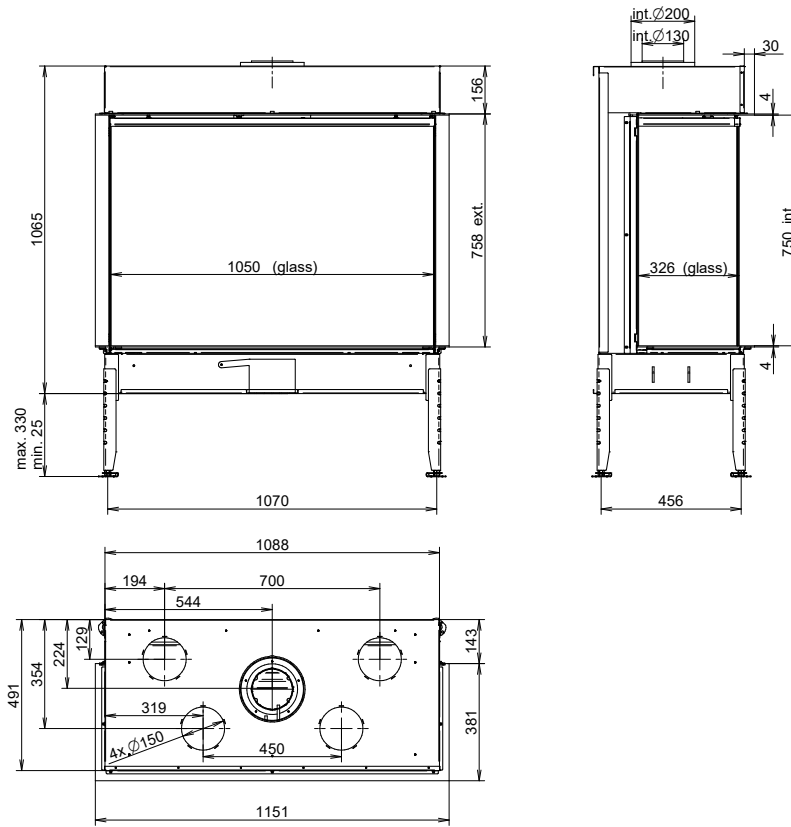

True Vision 1050 VDC

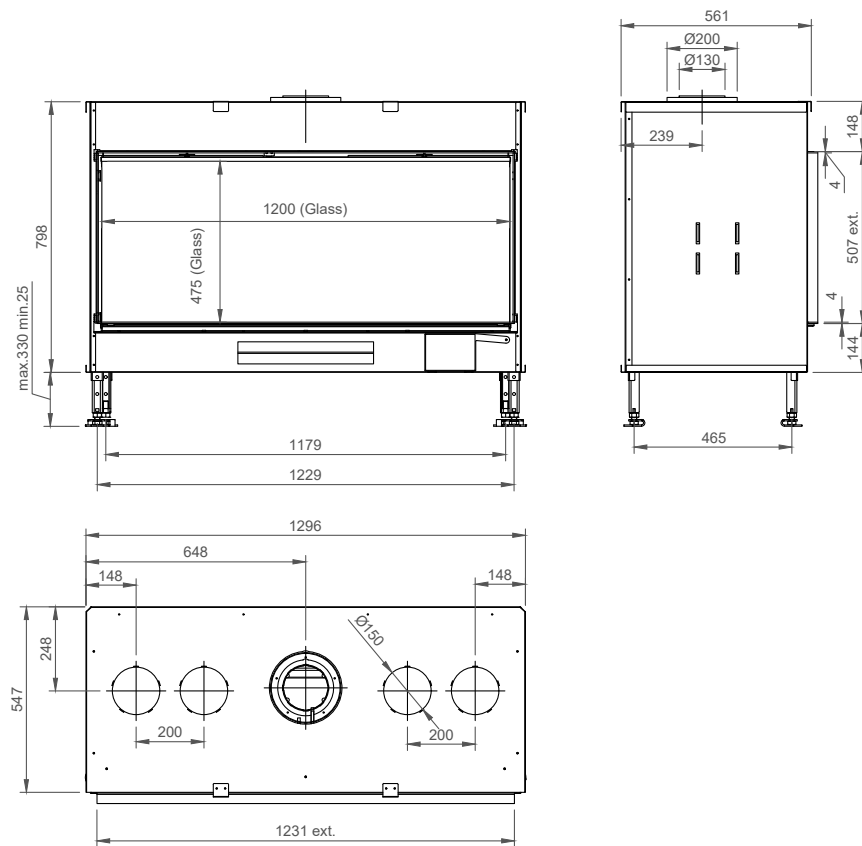

True Vision 1300H Quatro

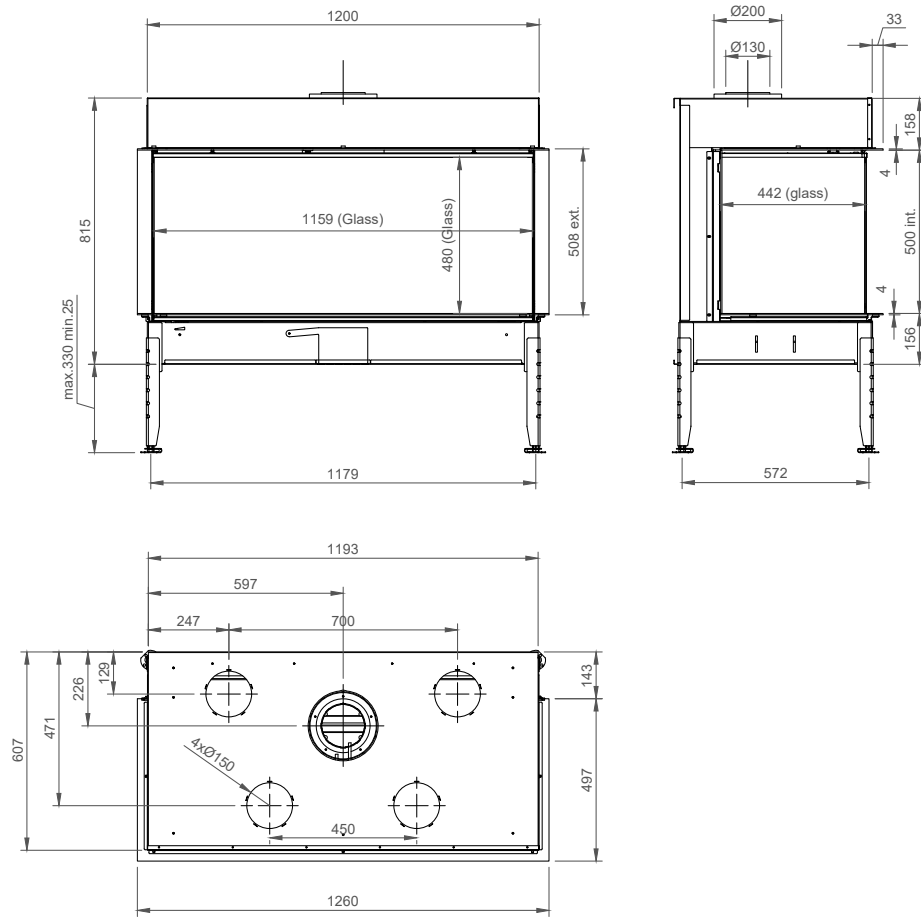

True Vision 1300DC Quatro

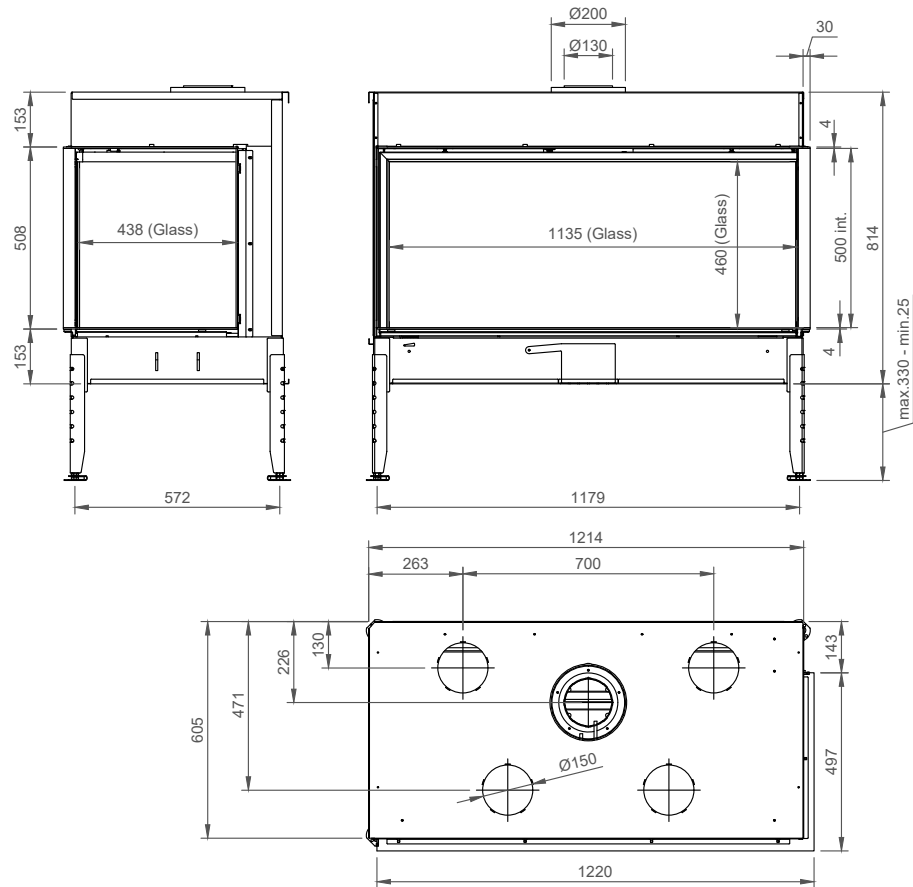

True Vision 1300CL/CR Quatro

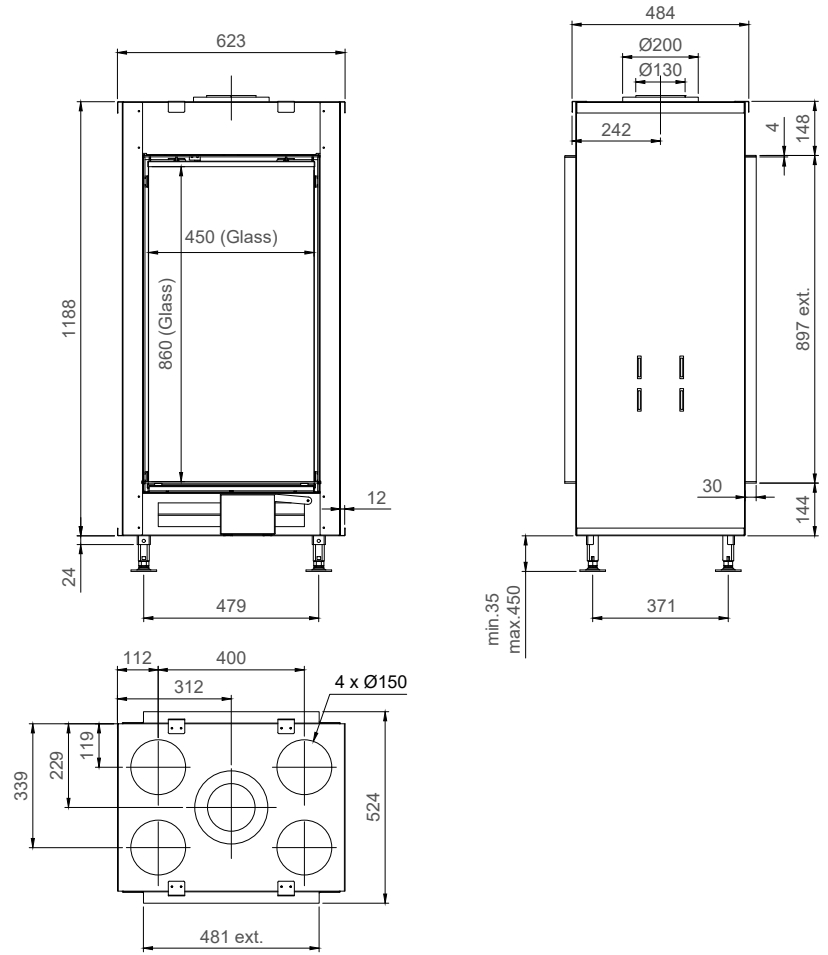

True Vision 550 DV

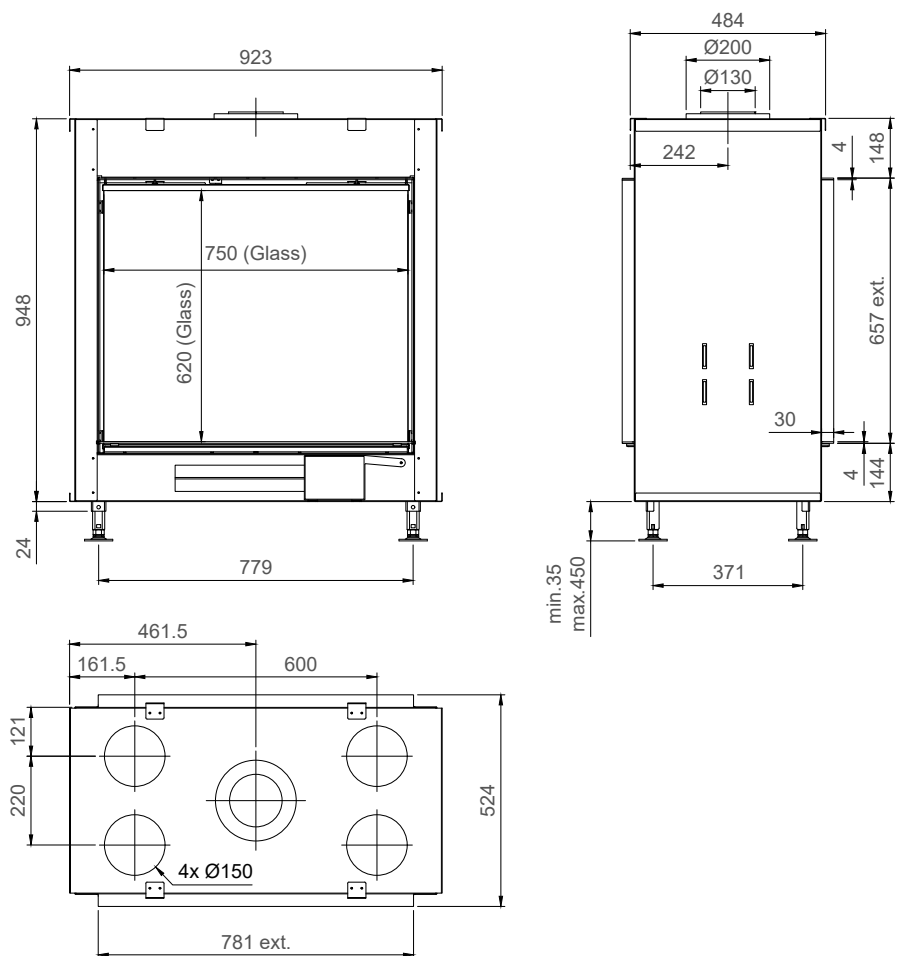

True Vision 850V

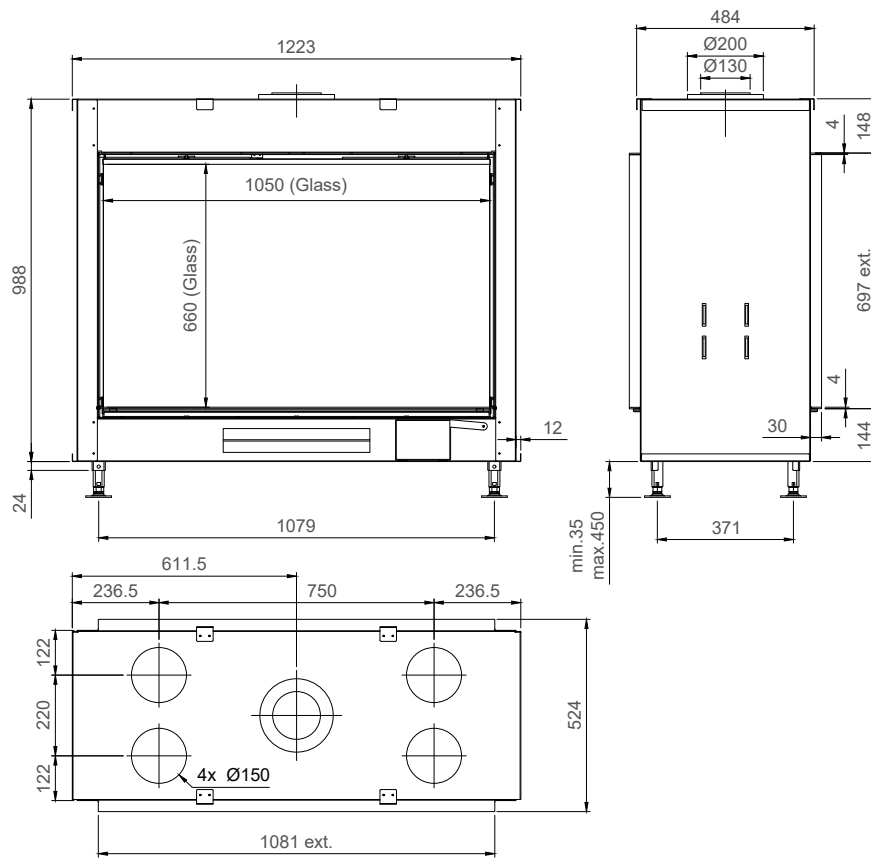

True Vision 1150DV

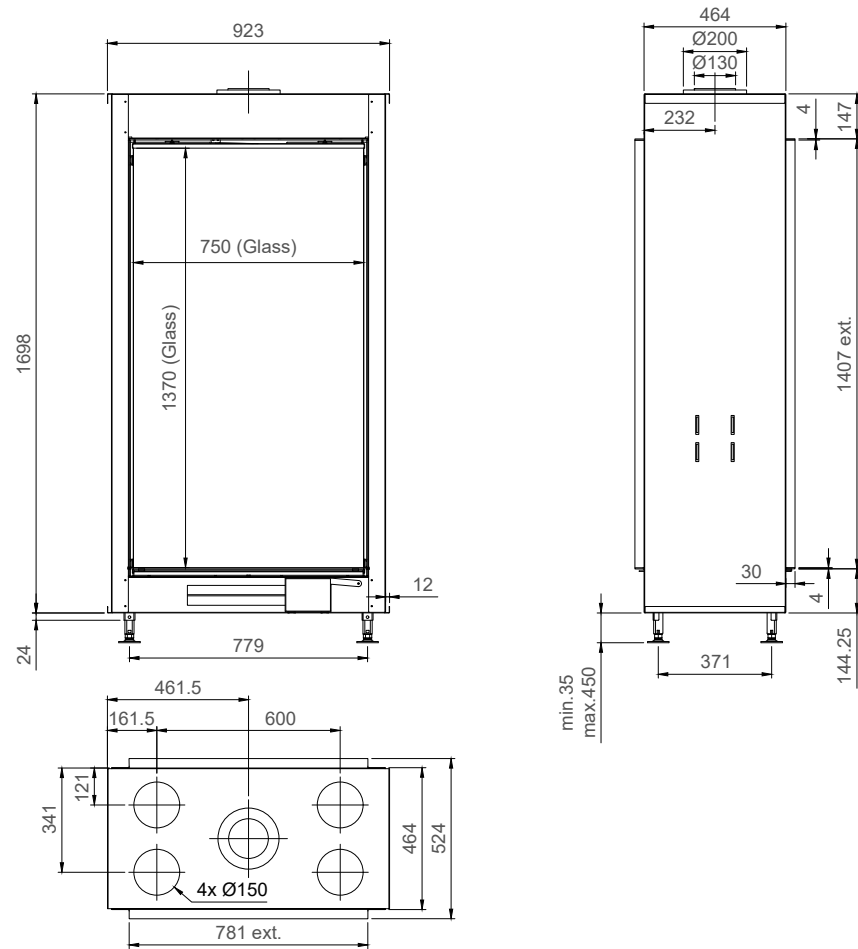

True Vision 850DVL

15. DESIGN GRILLS

